



National Défense  
Defence nationale

A-CR-CCP-177/PT-001

CANADIAN CADET MOVEMENT  
CADET MARKSMANSHIP PROGRAM  
REFERENCE MANUAL

(ENGLISH)

**(Supersedes A-CR-CCP-177/PT-001 dated 2001-09-01)**

Cette publication est disponible en français sous le numéro A-CR-CCP-177/PT-002.

**Issued on Authority of the Chief of the Defence Staff**

**OPI : NDHQ D Cdts 3**

**2005-09-14**

Canada<sup>🇨🇦</sup>

**LIST OF EFFECTIVE PAGES**

Insert latest changed pages and dispose of superseded pages in accordance with applicable orders.

**NOTE**

The portion of the text affected by the latest change is indicated by a black vertical line in the margin of the page. Changes to illustrations are indicated by miniature pointing hands or black vertical lines.

Dates of issue for original and changed pages are:

Original.....	0 .....	2005-09-14	Ch .....	3 .....
Ch.....	1 .....		Ch .....	4 .....
Ch.....	2 .....		Ch .....	5 .....

Zero in Change No. column indicates an original page. Total number of pages in this publication is 239 consisting of the following:

<b>Page No.</b>	<b>Change No.</b>	<b>Page No.</b>	<b>Change No.</b>
Cover.....	0	1B-1/1B-2 .....	0
A.....	0	1C-1 to 1C-2 .....	0
i to v/vi .....	0	Title – Part 2 .....	0
Title – Part 1 .....	0	i.....	0
i to iii/iv .....	0	2-1 to 2-26 .....	0
1-1-1/1-1-2 .....	0	Title – Part 3 .....	0
1-2-1 to 1-2-2 .....	0	i.....	0
1-3-1 to 1-3-4 .....	0	3-1 to 3-31 .....	0
1-4-1 to 1-4-4 .....	0	Title – Part 4 .....	0
1-5-1 to 1-5-15/1-5-16.....	0	i to ii .....	0
1-6-1 to 1-6-12 .....	0	4-1-1/4-1-2.....	0
1-7-1 to 1-7-12 .....	0	4-2-1 to 4-2-4.....	0
1-8-1 to 1-8-4 .....	0	4-3-1 to 4-3-7/4-3-8 .....	0
1-9-1 to 1-9-3/1-9-4.....	0	4-4-1 to 4-4-36.....	0
1-10-1 to 1-10-2 .....	0	4A-1/4A-2 .....	0
1-11-1 to 1-11-6 .....	0	4B-1/4B-2 .....	0
1-12-1 to 1-12-3/1-12-4.....	0	4C-1/4C-2 .....	0
1-13-1 to 1-13-3/1-13-4.....	0	4D-1/4D-2 .....	0
1-14-1 to 1-14-5/1-14-6.....	0	4E-1/4E-2 .....	0
1-15-1/1-15-2 .....	0	4F-1/4F-2.....	0
1-16-1 to 1-16-2 .....	0	GL-1 to GL-5/GL-6.....	0
1A-1/1A-2 .....	0	LA-1/LA-2 .....	0

**Contact Officer: NDHQ D Cdts 3**

© 2005 DND/MDN Canada

## TABLE OF CONTENTS

	<b>PAGE</b>
<b>PART 1 – AIR RIFLE TRAINING MANUAL .....</b>	<b>1-1-1/1-1-2</b>
<b>Section 1 – General.....</b>	<b>1-1-1/1-1-2</b>
<b>Section 2 – Cadet Marksmanship Programme.....</b>	<b>1-2-1</b>
2.1 Scope.....	1-2-1
2.2 Aim of Programme.....	1-2-1
2.3 Programme Objectives .....	1-2-1
2.4 Skill Development .....	1-2-1
2.5 Local Headquarters Training .....	1-2-2
2.6 Summer Courses .....	1-2-2
<b>Section 3 – Safety .....</b>	<b>1-3-1</b>
3.1 Safety Precautions.....	1-3-1
3.2 Safety Regulations.....	1-3-3
3.3 Range Safety Officer Training .....	1-3-3
3.4 Lead Contamination: Disposal of Lead and Personal Hygiene .....	1-3-4
<b>Section 4 – The Daisy 853C Air Rifle and Pellets .....</b>	<b>1-4-1</b>
4.1 Characteristics .....	1-4-1
4.2 Parts.....	1-4-1
4.3 Air Rifle Pellets.....	1-4-3
<b>Section 5 – Marksmanship Techniques – Prone Position .....</b>	<b>1-5-1</b>
5.1 Proper Eye Usage.....	1-5-1
5.2 The Prone Position .....	1-5-2
5.3 Aiming .....	1-5-5
5.4 Breathing.....	1-5-8
5.5 Trigger Control.....	1-5-9
5.6 Follow-Through.....	1-5-10
5.7 Loading, Firing and Unloading.....	1-5-10
5.8 Immediate Action and Stoppages.....	1-5-13
5.9 Dry Firing .....	1-5-14
5.10 Use of the Sling.....	1-5-14
<b>Section 6 – Marksmanship Techniques – Standing Position.....</b>	<b>1-6-1</b>
6.1 The Standing Position.....	1-6-1
6.2 Aiming .....	1-6-5
6.3 Breathing.....	1-6-8
6.4 Trigger Control .....	1-6-9
6.5 Follow-through .....	1-6-10
6.6 Loading, Firing and Unloading.....	1-6-10
<b>Section 7 – Marksmanship Techniques – Kneeling Position .....</b>	<b>1-7-1</b>
7.1 The Kneeling Position.....	1-7-1
7.2 Use of the Sling.....	1-7-4
7.3 Aiming .....	1-7-6
7.4 Breathing.....	1-7-9
7.5 Trigger Control .....	1-7-9
7.6 Follow-Through.....	1-7-10
7.7 Loading, Firing and Unloading.....	1-7-10

## TABLE OF CONTENTS (Cont)

	<b>PAGE</b>
<b>Section 8 – Ranges and Range Procedures</b> .....	<b>1-8-1</b>
8.1 General Safety .....	1-8-1
8.2 Portable Range Set-up and Maintenance .....	1-8-1
8.3 Range Types.....	1-8-2
8.4 Range Commands and Procedures .....	1-8-3
<b>Section 9 – Target and Scoring</b> .....	<b>1-9-1</b>
9.1 Targets.....	1-9-1
9.2 Scoring.....	1-9-1
<b>Section 10 – Cleaning</b> .....	<b>1-10-1</b>
10.1 Cleaning the Bore .....	1-10-1
10.2 Cleaning of Other Parts .....	1-10-2
<b>Section 11 – Maintenance</b> .....	<b>1-11-1</b>
11.1 Types of Maintenance.....	1-11-1
11.2 Disassembling the Rifle .....	1-11-2
11.3 Reassembling the Rifle.....	1-11-4
<b>Section 12 – Introduction to Coaching</b> .....	<b>1-12-1</b>
12.1 General .....	1-12-1
12.2 Duties.....	1-12-1
12.3 Firing Point Sequence.....	1-12-1
12.4 Competition Firing.....	1-12-2
12.5 Analysis of Common Errors .....	1-12-2
<b>Section 13 – Marksmanship Equipment</b> .....	<b>1-13-1</b>
13.1 General .....	1-13-1
13.2 Marksmanship Apparel .....	1-13-1
<b>Section 14 – Physical Training</b> .....	<b>1-14-1</b>
14.1 General .....	1-14-1
14.2 Warm-up Exercises to be Done Before Static Stretching.....	1-14-1
14.3 Static Stretching Exercises .....	1-14-2
14.4 Diet.....	1-14-4
14.5 Relaxation Techniques .....	1-14-4
<b>Section 15 – Mental Training</b> .....	<b>1-15-1/1-15-2</b>
15.1 General .....	1-15-1/1-15-2
15.2 Mental Imagery .....	1-15-1/1-15-2
<b>Section 16 – Training Plan &amp; Marksmanship Diary</b> .....	<b>1-16-1</b>
16.1 Goals.....	1-16-1
16.2 Training Plan.....	1-16-1
16.3 Marksmanship Diary .....	1-16-2
16.4 Sample Diary Sheet.....	1-16-2

**TABLE OF CONTENTS (Cont)**

	<b>PAGE</b>
<b>Annex A – Development of a Marksmanship Team .....</b>	<b>1A-1/1A-2</b>
<b>Annex B – Air Rifle Grouping Template .....</b>	<b>1B-1/1B-2</b>
<b>Annex C – Marksmanship Reference Material .....</b>	<b>1C-1</b>
<b>PART 2 – AIR RIFLE TRAINING AIDE-MÉMOIRE .....</b>	<b>2-1</b>
General .....	2-1
Safety .....	2-2
Air Rifle Ranges .....	2-4
The Daisy 853C Air Rifle and Pellets .....	2-5
Proper Eye Usage .....	2-6
Prone Position .....	2-7
Standing Position .....	2-9
Kneeling Position .....	2-11
Aiming .....	2-13
Natural Alignment .....	2-14
Breathing .....	2-15
Trigger Control and Follow-through .....	2-16
Use of the Sling .....	2-17
Loading, Firing and Unloading the Air Rifle .....	2-18
Pumping the Air Rifle .....	2-19
Cleaning the Air Rifle .....	2-20
Immediate Action and Stoppages .....	2-21
Range Commands and Procedures .....	2-22
Marksmanship Equipment .....	2-23
Physical Training .....	2-25
Coaching .....	2-26
<b>PART 3 – UNIT MARKSMANSHIP TRAINING PLAN.....</b>	<b>3-1</b>
<b>Introduction .....</b>	<b>3-1</b>
<b>Unit Marksmanship Team – Yearly Training Plan Overview .....</b>	<b>3-2</b>
<b>General Preparation Phase (6 Weeks – 01 Oct – 15 Nov) .....</b>	<b>3-4</b>
Week 1 – First Team Selection .....	3-4
Week 2 – Application of Marksmanship Principles I .....	3-5
Week 3 – Application of Marksmanship Principles II .....	3-6
Week 4 – Application of Marksmanship Principles III .....	3-7
Week 5 – Application of Marksmanship Principles IV .....	3-8
Week 6 – The Sling and Marksmanship Equipment .....	3-9
<b>Specific Preparation Phase (6 Weeks – 15 Nov – 22 Dec) .....</b>	<b>3-10</b>
Week 7 – Relaxation Techniques .....	3-10
Week 8 – Development of a Shot Routine I .....	3-11
Week 9 – Development of a Shot Routine II .....	3-12
Week 10 – Endurance Training I .....	3-13
Week 11 – Mental Training .....	3-14
Week 12 – Break .....	3-16

## TABLE OF CONTENTS (Cont)

	<b>PAGE</b>
<b>Pre-competition Phase (7 Weeks – 22 Dec – 15 Feb)</b> .....	<b>3-17</b>
Week 13 – Match Routine I.....	3-17
Week 14 – Match Routine II.....	3-18
Week 15 – Endurance Training II.....	3-19
Week 16 – Rhythm Training.....	3-20
Week 17 – Endurance Training III.....	3-21
Week 18 – Competition Simulation I.....	3-22
Week 19 – Competition Simulation II.....	3-23
<b>Competition Phase (6 to 8 Weeks – 15 Feb – 15 April)</b> .....	<b>3-24</b>
Week 20 – Development of Tactics.....	3-24
Week 21 – Competition Simulation III.....	3-25
Week 22 – Endurance Training IV.....	3-26
Week 23 – Competition Simulation IV.....	3-27
Week 24 – Zone Championship.....	3-28
Week 25 – Development of a Shot Routine III.....	3-29
Week 26 – Competition Simulation V.....	3-30
Week 27 – Provincial Championship.....	3-31
<b>PART 4 – MARKSMANSHIP CHAMPIONSHIP SERIES</b> .....	<b>4-1-1/4-1-2</b>
<b>Section 1 – Introduction</b> .....	<b>4-1-1/4-1-2</b>
<b>Section 2 – General Information</b> .....	<b>4-2-1</b>
Scope.....	4-2-1
Stages.....	4-2-1
Funding.....	4-2-1
Entry Fees.....	4-2-1
Competitors.....	4-2-1
Adult Coach.....	4-2-2
Cadet Coach.....	4-2-2
Equipment.....	4-2-2
Responsibilities for Implementation.....	4-2-2
Stage 1 – Local Unit Selection Championship.....	4-2-2
Stage 2 – Zone Championship.....	4-2-2
Stage 3 – Provincial/Territorial Championship.....	4-2-3
Stage 4 – National Championship.....	4-2-3
Matches.....	4-2-4
<b>Section 3 – Match Conditions</b> .....	<b>4-3-1</b>
Stage 1 – Local Unit Selection Championship.....	4-3-1
Stage 2 – Zone Championship.....	4-3-2
Stage 3 – Provincial/Territorial Championship.....	4-3-3
Stage 4 – National Championship.....	4-3-4
<b>Section 4 – Rules</b> .....	<b>4-4-1</b>
Foreword.....	4-4-1
1. General.....	4-4-2
2. Safety Regulations.....	4-4-3
3. Competitors – Eligibility Rules for Individuals and Teams.....	4-4-4

**TABLE OF CONTENTS (Cont)**

	<b>PAGE</b>
4. Meeting and Draws .....	4-4-6
5. Rifles .....	4-4-8
6. Equipment .....	4-4-9
7. Targets .....	4-4-11
8. Pellets .....	4-4-12
9. Facilities .....	4-4-13
10. Range Layout and Specifications .....	4-4-14
11. Coaching .....	4-4-17
12. Training .....	4-4-18
13. Competitors Relay Sequence .....	4-4-19
14. Range Commands .....	4-4-20
15. Competition Firing/Zeroing .....	4-4-21
16. Time Limits .....	4-4-23
17. Scoring .....	4-4-24
18. Results .....	4-4-26
19. Challenges .....	4-4-27
20. Protests .....	4-4-28
21. Infractions .....	4-4-29
22. Warnings, Penalties and Disqualifications .....	4-4-30
23. Jury .....	4-4-33
24. Supplementary Rules for Standing Match .....	4-4-35
<b>Annex A – Challenge Form/Formulaire de défi .....</b>	<b>4A-1/4A-2</b>
<b>Annex B – Protest Form/Formulaire de protêt .....</b>	<b>4B-1/4B-2</b>
<b>Annex C – Infraction Form/Formulaire d’infraction .....</b>	<b>4C-1/4C-2</b>
<b>Annex D – Challenge Register/Registre des défis .....</b>	<b>4D-1/4D-2</b>
<b>Annex E – Protest Register/Registre des protêts .....</b>	<b>4E-1/4E-2</b>
<b>Annex F – Infraction Register/Registre des infractions .....</b>	<b>4F-1/4F-2</b>
<b>GLOSSARY .....</b>	<b>GL-1</b>
<b>LIST OF ACRONYMS/ABBREVIATIONS .....</b>	<b>LA-1/LA-2</b>





# PART 1

---

## CANADIAN CADET MOVEMENT AIR RIFLE TRAINING MANUAL

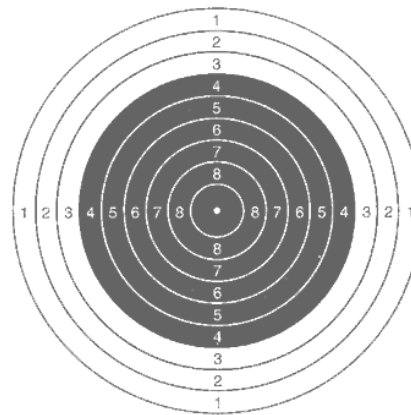



## TABLE OF CONTENTS

	<b>PAGE</b>
<b>PART 1 – AIR RIFLE TRAINING MANUAL .....</b>	<b>1-1-1/1-1-2</b>
<b>Section 1 – General.....</b>	<b>1-1-1/1-1-2</b>
<b>Section 2 – Cadet Marksmanship Programme.....</b>	<b>1-2-1</b>
2.1 Scope.....	1-2-1
2.2 Aim of Programme.....	1-2-1
2.3 Programme Objectives .....	1-2-1
2.4 Skill Development .....	1-2-1
2.5 Local Headquarters Training .....	1-2-2
2.6 Summer Courses.....	1-2-2
<b>Section 3 – Safety .....</b>	<b>1-3-1</b>
3.1 Safety Precautions.....	1-3-1
3.2 Safety Regulations.....	1-3-3
3.3 Range Safety Officer Training .....	1-3-3
3.4 Lead Contamination: Disposal of Lead and Personal Hygiene .....	1-3-4
<b>Section 4 – The Daisy 853C Air Rifle and Pellets .....</b>	<b>1-4-1</b>
4.1 Characteristics .....	1-4-1
4.2 Parts.....	1-4-1
4.3 Air Rifle Pellets.....	1-4-3
<b>Section 5 – Marksmanship Techniques – Prone Position .....</b>	<b>1-5-1</b>
5.1 Proper Eye Usage.....	1-5-1
5.2 The Prone Position .....	1-5-2
5.3 Aiming.....	1-5-5
5.4 Breathing.....	1-5-8
5.5 Trigger Control.....	1-5-9
5.6 Follow-Through.....	1-5-10
5.7 Loading, Firing and Unloading.....	1-5-10
5.8 Immediate Action and Stoppages.....	1-5-13
5.9 Dry Firing .....	1-5-14
5.10 Use of the Sling.....	1-5-14
<b>Section 6 – Marksmanship Techniques – Standing Position.....</b>	<b>1-6-1</b>
6.1 The Standing Position.....	1-6-1
6.2 Aiming.....	1-6-5
6.3 Breathing.....	1-6-8
6.4 Trigger Control.....	1-6-9
6.5 Follow-through.....	1-6-10
6.6 Loading, Firing and Unloading.....	1-6-10
<b>Section 7 – Marksmanship Techniques – Kneeling Position .....</b>	<b>1-7-1</b>
7.1 The Kneeling Position.....	1-7-1
7.2 Use of the Sling.....	1-7-4
7.3 Aiming .....	1-7-6
7.4 Breathing.....	1-7-9
7.5 Trigger Control.....	1-7-9
7.6 Follow-Through.....	1-7-10
7.7 Loading, Firing and Unloading.....	1-7-10

**TABLE OF CONTENTS (Cont)**

	<b>PAGE</b>
<b>Section 8 – Ranges and Range Procedures.....</b>	<b>1-8-1</b>
8.1 General Safety .....	1-8-1
8.2 Portable Range Set-up and Maintenance .....	1-8-1
8.3 Range Types.....	1-8-2
8.4 Range Commands and Procedures .....	1-8-3
<b>Section 9 – Targets and Scoring .....</b>	<b>1-9-1</b>
9.1 Targets.....	1-9-1
9.2 Scoring.....	1-9-1
<b>Section 10 – Cleaning.....</b>	<b>1-10-1</b>
10.1 Cleaning the Bore .....	1-10-1
10.2 Cleaning of Other Parts .....	1-10-2
<b>Section 11 – Maintenance .....</b>	<b>1-11-1</b>
11.1 Types of Maintenance.....	1-11-1
11.2 Disassembling the Rifle .....	1-11-2
11.3 Reassembling the Rifle.....	1-11-4
<b>Section 12 – Introduction to Coaching .....</b>	<b>1-12-1</b>
12.1 General .....	1-12-1
12.2 Duties.....	1-12-1
12.3 Firing Point Sequence.....	1-12-1
12.4 Competition Firing.....	1-12-2
12.5 Analysis of Common Errors .....	1-12-2
<b>Section 13 – Marksmanship Equipment .....</b>	<b>1-13-1</b>
13.1 General .....	1-13-1
13.2 Marksmanship Apparel.....	1-13-1
<b>Section 14 – Physical Training .....</b>	<b>1-14-1</b>
14.1 General .....	1-14-1
14.2 Warm-up Exercises to be Done Before Static Stretching.....	1-14-1
14.3 Static Stretching Exercises .....	1-14-2
14.4 Diet.....	1-14-4
14.5 Relaxation Techniques .....	1-14-4
<b>Section 15 – Mental Training .....</b>	<b>1-15-1/1-15-2</b>
15.1 General .....	1-15-1/1-15-2
15.2 Mental Imagery .....	1-15-1/1-15-2
<b>Section 16 – Training Plan &amp; Marksmanship Diary .....</b>	<b>1-16-1</b>
16.1 Goals.....	1-16-1
16.2 Training Plan.....	1-16-1
16.3 Marksmanship Diary .....	1-16-2
16.4 Sample Diary Sheet.....	1-16-2

**TABLE OF CONTENTS (Cont)**

	<b>PAGE</b>
<b>Annex A – Development of a Marksmanship Team .....</b>	<b>1A-1/1A-2</b>
<b>Annex B – Air Rifle Grouping Template .....</b>	<b>1B-1/1B-2</b>
<b>Annex C – Marksmanship Reference Material .....</b>	<b>1C-1</b>
<b>PART 2 – AIR RIFLE TRAINING AIDE-MÉMOIRE .....</b>	<b>2-1</b>
<b>PART 3 – UNIT MARKSMANSHIP TRAINING PLAN.....</b>	<b>3-1</b>
<b>PART 4 – MARKSMANSHIP CHAMPIONSHIP SERIES.....</b>	<b>4-1-1/4-1-2</b>



**PART 1**  
**AIR RIFLE TRAINING MANUAL**  
**SECTION 1**  
**GENERAL**

The purpose of this training manual is to consolidate, in handy reference form, information on air rifle firing. This manual is designed to educate all persons within the Canadian Cadet Movement (CCM) about the air rifle and to ensure that all cadet corps/squadrons have an equal opportunity to learn marksmanship skills. It also serves as a technical reference guide for coaches.

This manual has the following aims:

- a. To inform cadet corps/squadrons about the air rifle marksmanship programme;
- b. To improve cadets skill level in air rifle marksmanship;
- c. To assist Cadet Instructor Cadre (CIC) officers and civilian instructors (CI) in air rifle range set-up, range procedures, target scoring and coaching techniques;
- d. To identify proper cleaning methods, maintenance, and repair of the air rifle; and
- e. To introduce the implementation of physical and mental training exercises.

This manual does not take precedence over any Cadet Administrative Training Order (CATO), Canadian Forces Technical Order (CFTO), Canadian Forces Administrative Order (CFAO), or any other Department of National Defence (DND) regulation or order.

When an item refers to a right-handed marksman, the reverse of that item refers to a left-handed marksman.

References to the directions **left** and **right** are described from the perspective of a marksman that is in the firing position.

Suggestions for improvements to this document are encouraged and may be submitted to the Staff Officer responsible for marksmanship within each Area/Region.





## SECTION 2

### CADET MARKSMANSHIP PROGRAMME

#### 2.1 SCOPE

A recent survey conducted by the Directorate of Cadets confirmed that marksmanship is one of the most popular and appealing aspects of tri-service cadet training. The marksmanship programme places a greater emphasis on recreational marksmanship as a sport. Self-discipline, acceptance of responsibility and respect for firearms are but a few of the many positive benefits derived from this cadet programme.

The new programme is self-sustaining in that it allows all cadet corps/squadrons weekly access to an affordable, recreational and competitive marksmanship programme. It also provides Cadet Summer Training Centres with the resources and staff required to conduct marksmanship training.

#### 2.2 AIM OF PROGRAMME

The aim of the National Cadet Marksmanship Programme is to develop cadets' interest in marksmanship while promoting the safe and proficient use of firearms for sport and recreational purposes. Such activities are also valuable in helping cadet corps/squadrons achieve other aspects of the cadet programme related to leadership, citizenship and sensible living. Cadet rifle marksmanship, by being both challenging and fun, can also enhance the retention of cadets.

#### 2.3 PROGRAMME OBJECTIVES

The objectives of the National Cadet Marksmanship Programme are:

- a. To promote firearms safety;
- b. To develop marksmanship skills;
- c. To stimulate and maintain an interest in the CCM;
- d. To train CIC officers, CI and senior cadets in how to conduct firearms training; and
- e. To produce CIC and cadet coaches.

#### 2.4 SKILL DEVELOPMENT

Within each marksmanship discipline (air rifle, smallbore rifle and fullbore rifle), skill progression is determined through a system of training levels referred to as Training Components. The three (3) training components available in the air rifle discipline are:

- a. Familiarization;
- b. Classification; and
- c. Competition.

## **2.5 LOCAL HEADQUARTERS TRAINING**

Cadet corps/squadrons are responsible for conducting training at the Local Headquarters (LHQ) level. Training sessions can be conducted by cadet unit personnel (cadets, CIC officers, Civilian Instructors (CI) or volunteers) or in conjunction with various civilian marksmanship organizations.

### **NOTE**

A qualified air rifle Range Safety Officer (RSO) must be present at all times when training is conducted on the range. This manual will serve as a guide for this type of training, but will not compensate for formal training dispensed by the Regional Cadet Instructors School (RCIS).

## **2.6 SUMMER COURSES**

Most Cadet Summer Training Centres conduct marksmanship, biathlon and coach training with the Daisy 853C air rifle.

## SECTION 3

### SAFETY

Firearms safety is the number one priority on and off the range so everyone must do their part to prevent accidents. In this sport, the majority of incidents are caused by the ignorance of proper rifle operating procedures or by mishandling. Marksmanship can be an exciting sport when done safely.

#### 3.1 SAFETY PRECAUTIONS

##### 3.1.1 Safety Catch and Security Measures

The safety catch is a mechanism that, once engaged, prevents a rifle from firing by locking its trigger into place. It is located just in front of the trigger, on the trigger guard.

To engage the safety catch (ON) it must be pushed towards the right so no red can be seen. To fire, the safety catch must be pushed towards the left in the OFF position and a red mark must be seen on it. For maximum security, it is recommended that the safety catch be kept engaged until the rifle is ready for firing.

**Remember: Safety Catch**

**ON = no red (safe)  
OFF = red (ready)**

##### 3.1.2 Safety Rod

To ensure that air rifles are not removed from the firing point or stored with a pellet in the chamber or barrel, a safety rod is to be inserted in the barrel from the muzzle end. It consists of two (2) sections of wooden dowling joined together in a "T" shape (it can also be made of other materials). Dimensions are detailed in the diagram below. The tip of the safety rod is to be coloured red using an ink marker.

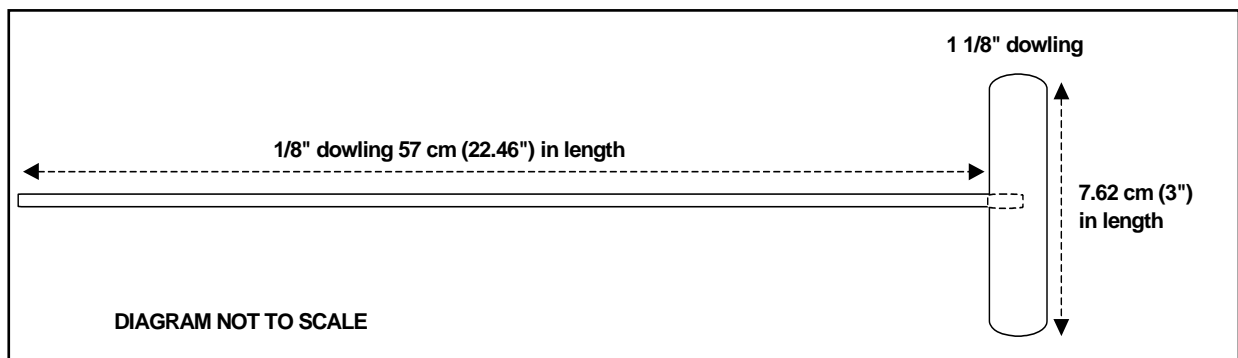

### 3.1.3 “Safe Rifle Status”

When not being handled on the range or in a training environment, the air rifle must be in a safe status. The following options denote various “safe rifle status”:

#### **Option One: In the rifle case**

- a. Safety catch is ON;
- b. Bolt is forward;
- c. Action is not cocked;
- d. Safety rod is in the case but not in the barrel; and
- e. Pump lever is partially open (5-8 cm).

#### **Option Two: On the firing line**

- a. Safety catch is ON;
- b. Bolt is to the rear; and
- c. Pump lever is partially open.

#### **Option Three: Not on the firing line**

- a. Safety catch is ON;
- b. Bolt is to the rear;
- c. Safety rod is in barrel (visible in the feed track); and
- d. Pump lever is partially open.

### 3.1.4 Removing a Rifle from the Case

The rifle case should be clearly marked on the outside with an arrow, indicating in what direction the rifle inside is pointing. This will ensure that when the case is opened, the rifle is pointing in a safe direction. The following steps must be followed in removing a rifle from its case:

- a. Place the rifle case on a flat surface and ensure the arrow is pointing in a safe direction;
- b. Open the case;
- c. Cock the action (leave the bolt to the rear);
- d. Confirm that the safety catch is ON;
- e. Confirm that the pumping lever is partially open;
- f. Slide the safety rod in the barrel towards the bolt until it can be seen in the feed track;
- g. Remove the rifle from the case; and
- h. Remove the safety rod if you are on the firing line.

### 3.1.5 Individual Safety Precautions

Upon receiving a rifle or when the “safe rifle status” is uncertain, individual safety precautions should be done to confirm that the rifle is safe. An individual must ensure that:

- a. The bolt is open fully to the rear;
- b. The safety catch is in the ON position;
- c. The pump lever is partially open; and
- d. A safety rod is inserted in the barrel.

#### NOTES

1. If an individual is taking a position on the firing line and an instructor has pre-positioned a rifle, a safety rod is not required.
2. Instructors/coaches must ensure that they complete individual safety precautions on all rifles to be used for instruction or firing on the range, before allowing cadets to handle the rifles as well as before removing rifles from the firing line.

### 3.2 SAFETY REGULATIONS

Safety regulations are all common sense and are easy to apply when people understand why they are necessary to help prevent accidents.

The following is a list of essential safety regulations:

- a. A rifle should always be treated as if it is loaded and be considered dangerous unless proven otherwise;
- b. A rifle should never be pointed at anyone;
- c. A rifle should always point in a safe direction. In the firing position, it should always point down range toward the targets;
- d. A rifle should be held in the vertical position with the muzzle pointing up when transporting it to and from the firing point and/or range;
- e. Fingers should be kept off the trigger unless the marksman is ready to fire;
- f. Hearing protectors may be worn when firing an air rifle; and
- g. The wearing of safety glasses or shatterproof eyeglasses is mandatory when firing. The wearing of specialized glasses is permitted **only** if the lens completely covers the aiming eye and a blinder which provides appropriate protection is installed to cover the non-aiming eye. All range staff must also wear safety glasses.

### 3.3 RANGE SAFETY OFFICER TRAINING

All CIC officers who are interested in conducting air rifle live firing practices must have successfully completed the Air Rifle RSO Course. This course deals with range safety criteria, conducting a range practice, carrying out range personnel taskings, exercise planning and preparation, and range conduct (set-up, briefing, firing practice, after firing).

### **3.4 LEAD CONTAMINATION: DISPOSAL OF LEAD AND PERSONAL HYGIENE**

Although there have only been a few authenticated cases of lead poisoning from rifle firing, all air rifle marksmen should take precautions to reduce any potential for lead contamination. Firearms that use cartridges generate most of their contaminants as a result of burning propellants and primers. Obviously this is not a consideration in this discipline. However, each time someone handles pellets, a small trace of lead is left on their hands and can be transferred to other parts of their body or to food. Over a period of time, this contact could increase lead levels in the body. It is therefore recommended that hands be washed thoroughly following all contact with pellets.

Spent pellets are regarded as hazardous waste and must be disposed of in accordance with local regulations.

## SECTION 4

### THE DAISY 853C AIR RIFLE AND PELLETS

#### 4.1 CHARACTERISTICS

- a. **Action:** Single pump pneumatic, straight pull-bolt;
- b. **Total length:** 97.8 cm;
- c. **Total weight:** 2.5 kg;
- d. **Calibre:** 0.177 calibre (4.5 mm);
- e. **Front sight:** Global type with interchangeable aperture inserts;
- f. **Rear sight:** Fully adjustable peep rear sight with micrometer click adjustment;
- g. **Barrel:** Lothar Walther rifled high-grade steel barrel with weight: crowned 12 lands and grooves, right hand twist. Precision bore sized for match pellets. Approximate length 53.1 cm;
- h. **Muzzle velocity:** 150.8 metres per second;
- i. **Maximum range:** 235.4 metres;
- j. **Loading:** Single or auto indexing five (5) pellet clip;
- k. **Stock:** Full-length, sporter-styled hardwood with adjustable length;
- l. **Sling:** Adjustable competition web;
- m. **Trigger weight:** Minimum 3.5 pounds;
- n. **Chamber:** Open loading and made of steel;
- o. **Safety:** Manual crossbolt trigger block with red indicator; and
- p. **Pumping force:** 20 lbf.

#### 4.2 PARTS

- a. **Butt Plate (End of the butt).** It is part of the rifle directly in contact with the marksman's shoulder. It is adjustable in length with the addition of butt spacers. When fitted properly, the butt plate aids in achieving a snug fit and a consistent placement of the rifle into the shoulder;
- b. **Spacers.** Plastic inserts that can be added or removed from the butt plate to vary its length. To add or take away butt spacers, simply use a Phillips screwdriver to loosen the butt plate and slide in/out the amount of spacers desired;
- c. **Small of the Butt (Pistol Grip).** Curved area directly behind the trigger guard where the hand controlling the trigger grips the rifle;
- d. **Stock.** Complete wooden portion of the rifle (from the butt plate end forward);

- e. **Fore End (of the Stock).** Wooden portion of the stock from the trigger guard forward, in which the barrel and the rifle mechanism are encased;
- f. **Sling.** Links the rifle to the marksman's arm and supports most of the weight of the rifle. It is a web sling made of nylon. One end attaches to the sling bracket and the other to the upper arm;
- g. **Sling Bracket (Handstop).** Adjustable metal clasp attached to the forestock and where the sling is fixed to the rifle. It also acts as a handstop (device used to rest the left hand to prevent it from moving);
- h. **Trigger.** Movable device that releases a spring and sets off the rifle mechanism. This rifle has a single stage trigger that cannot be adjusted for weight;
- i. **Trigger Guard.** Metal area that surrounds and protects the trigger;
- j. **Safety Catch.** This is a mechanism that, once engaged, prevents the rifle from firing by locking the trigger in place. It is a cross bolt type device located on the trigger guard. The black side indicates that the rifle is unable to fire; the red side indicates the rifle is ready to fire. It should be ON (no red) at all times, except when firing;
- k. **Bolt.** Metal lever used for opening or closing the rifle mechanism. It must be in the closed position in order to fire. For maximum safety when not firing, the bolt should be kept open;

#### NOTE

When a rifle is stored the bolt should be forward and the action must not be cocked.

- l. **Pump Lever.** Metal lever used to compress the air required to fire the pellet. Whenever the rifle is in a "safe rifle status", the pump lever should be left partially open;
- m. **Sight System**
  - (1) **Front Sight.** Global front sight that uses aperture inserts; and
  - (2) **Rear Sight.** Micrometer sight adjustable for windage and elevation. It is easily attached to the metal rail located above the action. This rail allows you to slide the sight forward or backward in order to maintain proper eye relief. The sight is tightened using a small flat-blade screwdriver;
- n. **Muzzle.** Front end of the barrel equipped with attachable barrel weight;
- o. **Barrel with Barrel Weight.** Steel tube extending from the muzzle to the chamber, through which the pellet travels. The barrel weight ensures that the rifle's weight is evenly distributed and that the rifle's balance is maintained;
- p. **Bore.** Interior of the barrel which has spiral grooves cut into it. The lands are the ridges of metal between the grooves. Together, the grooves and lands are called rifling;
- q. **Feed Track.** Delicate area where the pellet is inserted manually onto the single pellet adapter or with a five (5) pellet clip;
- r. **Single Pellet Adapter.** Plastic clip that aids in placing a pellet in the chamber;
- s. **Five (5) Pellet Clip.** Plastic clip that holds a maximum of five (5) pellets and used to place the pellets in the chamber; and



- t. **Chamber.** Place where the pellet is held before firing.

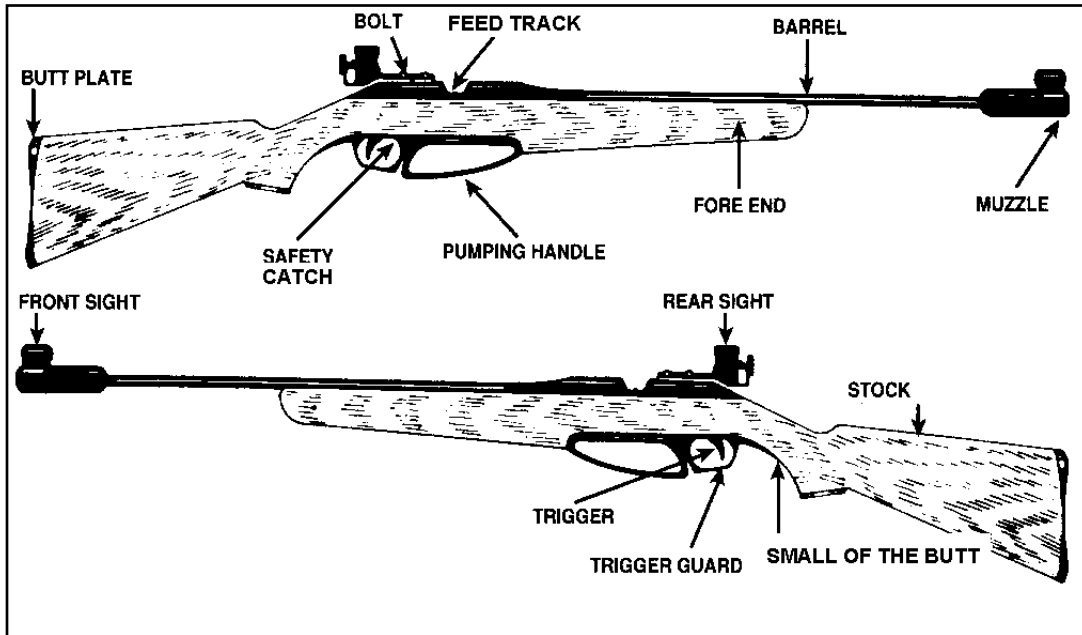

## 4.3 AIR RIFLE PELLETS

### 4.3.1 General

Air rifles are very sensitive to variations in pellet design and construction. The relationship between pellet fit in the breech and response to peak pressure during firing is critical in obtaining optimal pellet performance. Extensive testing to confirm performance and accuracy was conducted prior to adopting the current air rifle pellet. Additional testing on an as required basis will be conducted to ensure that the pellets in service provide an optimal cost-benefit performance for marksmanship training and competition.

### 4.3.2 Pellet Design and Type

- a. **Diabolo.** The most popular pellet design is the hourglass-shaped air rifle pellet, commonly referred to as the diabolo. The term is derived from the pellet's resemblance to the spool-shaped device used in an ancient Greek throwing game called diabolo. The "waisted" design of the pellet minimizes the friction between the pellet and the rifling. The thin hollow base (or skirt) expands during its travel down the bore to grip the rifling grooves and to establish an effective air seal. The pellet head is slightly smaller in diameter than the skirt and simply rides the rifle barrel lands. In a well-designed diabolo pellet, most of the pellet weight is forward of the skirt in the head of the pellet. This gives the pellet maximum stability in flight – similar in concept to a badminton shuttle.
- b. **Wadcutter.** There are a number of variations on the basic diabolo design. These variations are based upon the intended use of the pellet. For marksmanship and competition training, the wadcutter pellet is used. This flatheaded pellet is designed for cutting neat, clean holes in paper, which allows for accurate, precise scoring of the target. Only diabolo-design wadcutter pellets supplied by the Canadian Forces (CF) are authorized for use in cadet air rifles. Despite its non-aerodynamic appearance, the wadcutter pellet's ballistics are not affected by its flathead design at distances less than 15 metres. In fact, in many instances the wadcutter has better accuracy at short ranges, such as ten metres. Since all cadet training and competitions use a ten-metre range, the flathead pellet design is not a factor in ballistic performance or accuracy.

### **4.3.3 Factors Affecting Ballistics**

The most important factor affecting the performance of a pellet is the uniformity of its hollow base. The skirt area has a thin wall that may be easily deformed due to the softness of the pellet head. These deformities affect the pellet's ability to grip the rifle and the balance of air pressure on the pellet. Consequently, optimal muzzle velocity and accuracy will not be achieved.

A simple test to confirm whether or not a pellet is deformed is to roll it on a smooth surface and observe whether or not it rolls smoothly. If the pellet wobbles or jerks, it is out of balance or deformed, and this will decrease its accuracy.

## SECTION 5

### MARKSMANSHIP TECHNIQUES – PRONE POSITION

This section deals with all the marksmanship skills required for proper firing. They can be divided into five principles as follows:

- a. Position;
- b. Holding;
- c. Breathing;
- d. Aiming; and
- e. Trigger Control.

These principles must all function in harmony. Improving one while not working on another will not provide very good results in the long run. Perfecting these principles takes time and concentration, cadets should remember – **PRACTICE MAKES PERFECT!**

#### 5.1 PROPER EYE USAGE

##### 5.1.1 Selecting the Master Eye

Everyone has a master (or dominant) eye which is stronger than the other one. This is the eye to be used when aiming. The master eye is the brain's primary source for the visual image of what we see. The non-master eye is used primarily for depth perception or sense of direction.

The master eye must be determined before individuals begin firing. It should be noted that the master eye is not always on the same side of the body as the writing hand.

To determine the master eye, cadets should follow the steps listed below:

- a. Select a small object (i.e., the corner of a wall) at least five (5) metres away;
- b. Face the object and extend both arms in front of their body towards the object;
- c. With both eyes open, form a small, tight opening around the object with their thumbs and index fingers;
- d. Look at the object through the opening with both eyes open and draw both hands back toward their face. Ensure that the object remains centred through the opening of their thumbs and index fingers; and
- e. They should now be looking through the opening at the object with one single eye – the stronger of the two. This is their master eye. They should always use this eye for aiming when they fire.

If the master eye is on the opposite side of the body than the writing hand, it is advisable that cadets change shoulders and fire with their opposite hand and use their master eye. This should not however be done at the expense of the cadet's comfort.

#### NOTE

If changing shoulders in order to accommodate the master eye proves uncomfortable, cadets should fire the way they feel most comfortable.

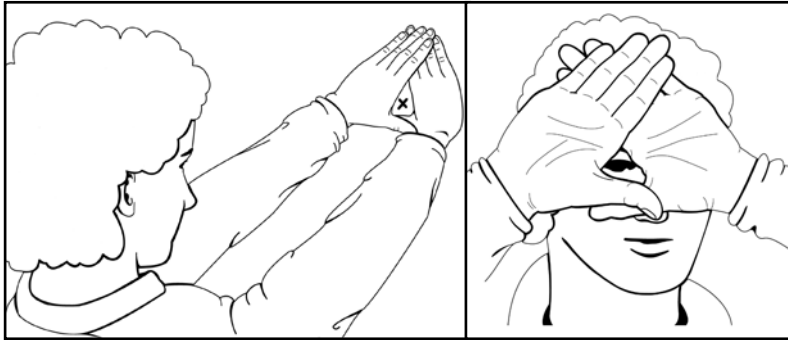

### 5.1.2 Firing with Both Eyes Open

Cadets should always fire with both eyes open. Eyes are constantly working together. If one is closed, the other will have to strain and the individual's vision will be affected. If cadets have difficulty focusing, the use of a blinder in front of the non-aiming eye will help prevent squinting and eye fatigue.

Cutting a piece of plastic from a windshield washer fluid jug or any other similar type of container can easily make a blinder. A good blinder should be translucent (plastic or paper) so that images are blocked even though light can penetrate it. It should be easily attachable to the rear sight or to the cadet's glasses.

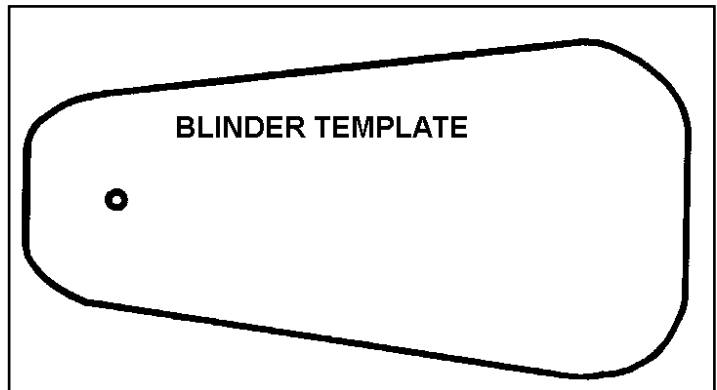

### 5.1.3 Avoiding Fixed Vision

If the marksman's vision is fixed on one object, such as a target bullseye, for more than a few seconds, the image of the bull will be burned in their mind and a "ghost" image of the bull will be seen when glancing to the side. It is especially important for cadets to avoid this fixed vision, because it results in a loss of visual perception and can greatly hinder their performance. To avoid fixed vision, cadets need only to blink or slightly shift their vision every four (4) or five (5) seconds.

## 5.2 THE PRONE POSITION

### 5.2.1 General

Obtaining a good prone position is one of the most, if not the most important principle of marksmanship. A good prone position helps to maintain comfort and stability during the firing session. Although an excellent position will not guarantee an excellent performance, a poor position can almost assure a substantially negative effect on results.

### 5.2.2 Rifle Rests

An excellent way to practice the marksmanship skills required by a cadet is to use a rifle rest such as a sandbag, a scope stand or a pile of books. This allows the cadet to perfect and to understand their marksmanship skills while the rifle is held steady. Once these skills are learned, the rifle rest should be removed and replaced by the sling.



### 5.2.3 Obtaining a Good Position

The objective of a good position is to obtain a stable, uniform platform in the most efficient way possible allowing holding and aiming to be achieved with as little movement and muscular tension as possible.

The position should be:

- a. Natural;
- b. Without strain;
- c. Comfortable;
- d. Stable;
- e. As such that body weight is equally distributed; and
- f. Consistent throughout the relay.

### 5.2.4 Characteristics of a Good Position

The characteristics of a good prone position are as follows:

- a. The body should form a 5-20° angle to the line of sight;
- b. The body should not be twisted and the spine should be straight;
- c. The left leg should be parallel with the spine;
- d. The right foot should turn out and point to the right; the left foot should be straight behind on the toe or pointed to the right according to the comfort of the individual;
- e. The right knee should be brought up so that the thigh forms an angle between 30-45° with the left leg. The right knee should be bent in order to improve stability. This causes the body to roll slightly to the left, raising the diaphragm off the ground, thus enhancing breathing. As the chest is also raised off the ground, body movements caused by normal heartbeat are minimized;
- f. The left elbow should be positioned slightly to the left of the rifle. It should not be positioned directly under it or stability will be affected. In order to maintain consistency throughout the relay, the left elbow should not be moved, even while pumping the rifle;

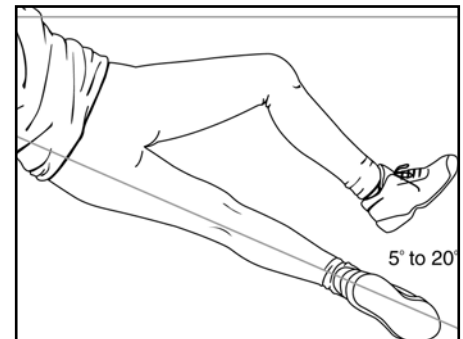
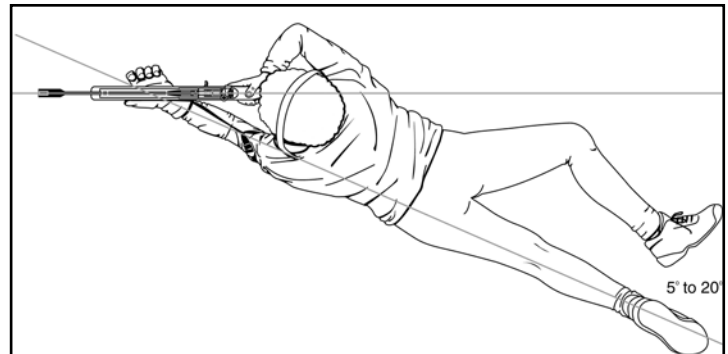

- g. In accordance with the CCM Marksmanship Championship Series Rules, the left forearm must form at least an angle of 30° with the ground;

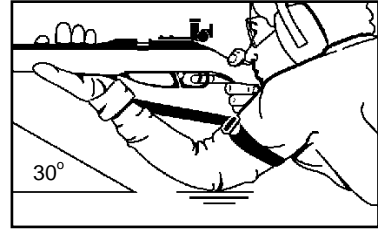

- h. The left hand should rest in the sling and firmly against the sling swivel and the fingers should not grip the fore end of the stock. The hand should be relaxed and the rifle should rest in the palm of the hand;

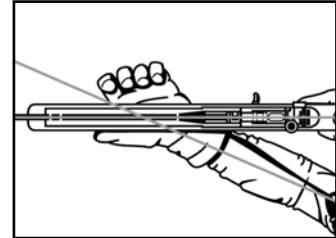

- i. Once a good position is established, the right hand should grip the small of the butt with constant pressure. The force applied by the right hand should never have to support the rifle. If a distinct pressure is necessary in order to keep the rifle in place, some aspect of the position will have to be changed;

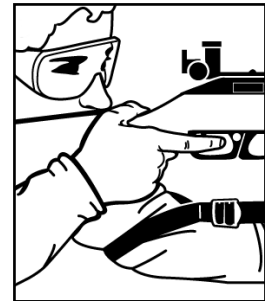

- j. The right thumb should be placed on the stock directly behind the rear sight or around the small of the butt;

- k. The position of the right elbow is established after the rest of the body is in place. After placing the right hand on the small of the butt, the right elbow should rest naturally where it falls and feels comfortable. However, the elbow should not be too close or too far from the rifle and it should only bear a small amount of pressure;

- l. The shoulders should be straight and form right angles with the spine;

- m. The butt plate is kept firmly in the hollow of the right shoulder. In order to ensure that the butt plate is always placed in the same spot, cadets should grasp it with their thumb and forefinger and place it in their shoulder for each and every shot. The right elbow will naturally fall in the same spot throughout the relay; and



- n. The head rests comfortably on the butt and remains straight. There should be a minimal distance of approximately five (5) cm between the right eye and the rear sight (known as eye relief). This distance should remain constant throughout the relay. When the face is placed on the butt, the cadet should be looking directly through the sights. If this is not the case, their position should be modified.

To ensure positive results, the aforementioned points should be repeated for each shot. The elbows should always be in the same place, the head should exert the same amount of pressure on the rifle, the eye relief should remain constant and the right knee should always be in the same position. If any of these points does not feel right or if cadets find their position uncomfortable, they should readjust it until it is perfect.

### 5.2.5 Adopting the Prone Position Using a Rifle Rest

The following steps should be adhered to when adopting the prone position using a rifle rest:

- a. Lay down to the left of their rifle;
- b. Place the left elbow on the ground;

- c. Pick up the rifle;
- d. Lay the rifle on the rest;
- e. Get into a comfortable position while keeping the rifle on the rest;
- f. Place the butt plate into the right shoulder;
- g. Rest their cheek on the butt;
- h. Place the right elbow on the ground;
- i. Adjust the height of the rest; and
- j. Adjust the length of the butt using spacers.

### 5.3 AIMING

#### 5.3.1 Front Sight

The front sight on the Daisy 853C is hooded. This is a feature found on most competition rifles to shield the front sight aperture from overhead or side light. The hood is formed by a short tube and is supported by a slender base which is attached to the rifle barrel.

The front aperture should be selected to provide the best sight picture. There are three (3) front sight inserts that come with the Daisy 853C: one (1) post sight and two (2) aperture-type sights. The post sight should not be used in cadet air rifle marksmanship. A good sized aperture should appear 1-1/2 times bigger than the aiming mark, as seen in paragraph 5.3.5.

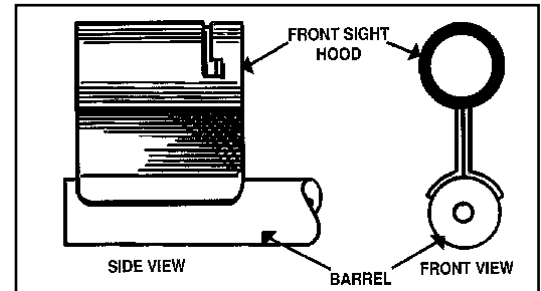

#### 5.3.2 Rear Sight

The part of the rear sight that is looked through is the peep sight. It is a small disk about the size of a penny with a small hole in it.

The rear sight has two (2) knobs that are used to move the point of impact of the shot. The **elevation** knob (on top) moves the point of impact up or down on the target. The **windage** knob (on the right side) moves the point of impact left or right. The adjustment of the knobs is measured in clicks that can be felt as the knob is turned.

It takes three (3) clicks to move the point of impact approximately one pellet width. At a distance of ten (10) metres, each click equals approximately a 1.219 mm shift of the point of impact.

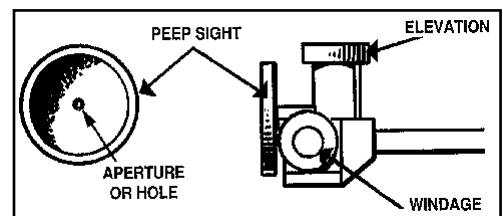

- a. **Elevation.** To lower the point of impact, turn the elevation knob counterclockwise (to the left). To raise the point of impact, turn the elevation knob clockwise (to the right), as per the arrow and the word "UP".
- b. **Windage.** To move the point of impact to the left, turn the windage knob counterclockwise (to the left). To move the point of impact to the right, turn the windage knob clockwise (to the right), as per the arrow and the letter "R".

#### Remember: Sight Adjustment

**UP & RIGHT = clockwise**  
**DOWN & LEFT = counterclockwise**

On scoring targets no initial sight adjustment should be made until cadets have fired at least a five (5) shot group. They should also avoid changing their sights after each shot (this is called “chasing the shot”) since centering the group is the main goal in marksmanship.

- c. **Backlash.** Sights are adjusted by turning a knob that is actually the head of a bolt. This bolt passes through a mating nut that holds the rear sight aperture. As the knob is turned, the nut moves accordingly, and the rear sight slides in a guide. As in all screw threads, there must be clearance between the threads in this nut and bolt combination, and this results in “backlash”, which must be taken up before the nut actually moves.

#### NOTE

To compensate for this, **always make the final sight adjustment by turning the adjusting knob clockwise.** For example, there is no problem if the sight adjustment requires turning the knob clockwise. However, if the sight adjustment requires turning the knob counterclockwise, it should be turned counterclockwise two (2) clicks farther than required, and **then** turned two (2) clicks clockwise.

### 5.3.3 Proper Head Position

The head should be kept as close as possible to a position which allows the eyes to look straight forward from the eye socket. To illustrate the penalty for not doing this, cadets should try moving their eyes as far in one direction as they can (up, down, right or left) in the eye socket. Instantly they will feel a strain on their eyes. The closer they can position their head so that their eyes are looking straight forward from the eye socket, the more relaxed their eye muscles will be. It is perfectly normal to tilt the head forward slightly, but cadets must resist allowing it to tilt to the left or right as this affects their sense of balance.

### 5.3.4 Eye Relief

Eye relief is the distance between the eye and the rear sight. Depending on an individual’s build and position, this distance is usually 5 to 15 cm. This distance may have to be reduced slightly due to the size of the Daisy 853C rifle. Cadets should strive to achieve an eye relief that is comfortable, natural, and allows them to see a circle of light around the front sight as they look through the rear sight. It is important for them to maintain the same eye relief from shot to shot and to find an eye relief that allows them to keep their head as erect as possible during the firing process. If they get closer to the sight than 5 cm, the line of white around the front sight becomes larger and more difficult to keep aligned.

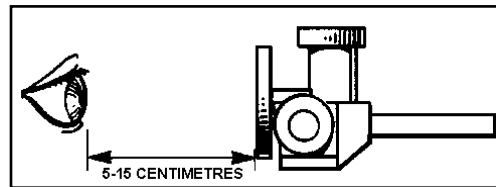

### 5.3.5 Sight Alignment

Sight alignment is the most critical element of the aiming process. It is the alignment of the eye, the rear sight, and the front sight.

When cadets bring their eye 5 to 15 cm from the rear sight, they will find that the small hole is large enough to look through and see all of the front sight. This is what they see when they have achieved proper sight alignment.

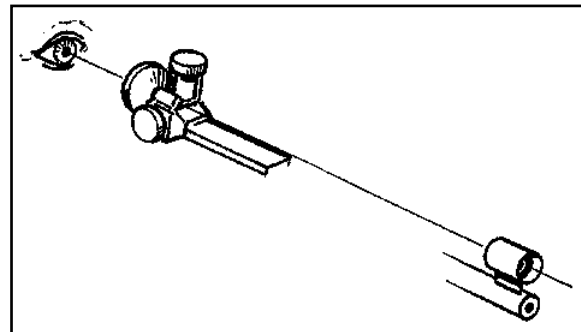



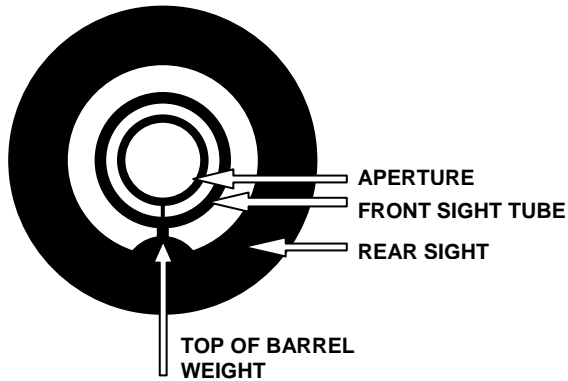

Proper sight alignment is a matter of centering the front sight hood in the rear sight. The hood will not quite fill the rear sight and cadets will be able to see light around the outside of the hood; we call this a “line of white”.

#### NOTE

To keep the sights properly aligned, the line of white must be equal on all sides.

### 5.3.6 Sight Picture

To obtain a proper sight picture, a bullseye is simply added to the innermost ring. The goal during the aiming process is to maintain proper sight alignment while keeping the bull centered in the front sight.

The ultimate goal is to have all the circles in perfect alignment, but even some expert marksmen can only reach this perfection and hold it for no more than a few seconds at a time.

To a cadet who is concentrating on sight alignment, any movement of the rifle while aiming will make it appear as though the bull is moving around within the front sight aperture. This apparent movement of the bull should not overly concern the beginning individual.

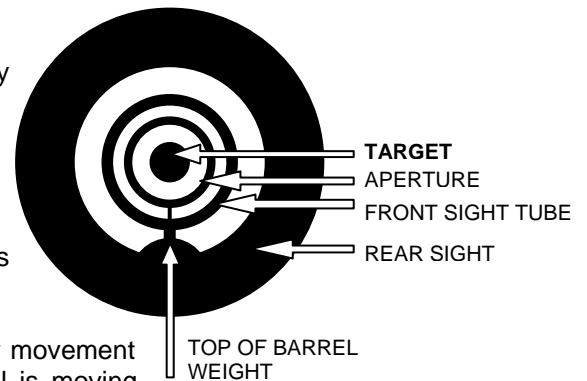

Cadets must constantly strive to maintain proper sight alignment, while obtaining a sight picture. It is the most critical element of the aiming process.

### 5.3.7 Natural Alignment

Natural alignment is obtained when the rifle can be perfectly aimed at the target without being muscled into achieving this. In a comfortable position, the cadet does not force the air rifle to point to the target, which would create muscular tension. Proper alignment will also prevent “drifting” of the group during a course of fire.

After establishing a comfortable position, the cadet must now make sure that their body and rifle are directly aligned with the target. In order to understand the notion of natural alignment it is important to remember that the rifle is supported by the bones and not the muscles.

In order to ensure that the position is directly in line with the target, cadets should follow these steps:

- a. Assume the prone position, look through the sights and acquire a proper sight picture;
- b. Close their eyes, take several normal breaths and relax into a comfortable position;
- c. Once comfortable, look through the sights again. If they are perfectly centered with the target, proceed with firing;
- d. If they are not directly centered with the target, they must re-orient their position slightly. To do this, they will need to pivot their body on the left elbow, more precisely:
  - (1) if they are aiming too far to the left, they move their lower body slightly to the left;

- (2) if they are aiming too far the right, they move their lower body slightly to the right;
  - (3) if they are aiming too low, they move their lower body slightly back (if this does not work, they can tighten their sling); and
  - (4) if they are aiming too high, they move their lower body slightly forward (if this does not work, they can loosen their sling);
- e. Close their eyes and do a final check on their alignment. If they are still not perfectly aligned, they must start over! They must remember to never move their left elbow when they shift their position around.

Again, it is essential that cadets use their bones to support the rifle, so that their muscles remain relaxed. Under no circumstances should they use their muscles to change the point of aim by moving the rifle from side to side. If they do a proper follow-through, the rifle will automatically return to the point of aim.

It is also important that cadets check their alignment during their course of fire to ensure their position has not shifted. Note also that “warmed” muscle groups react differently from “cold” muscle groups. It is important to allow for a proper warm-up prior to firing. A brief warm-up exercise is described in Section 12.

### **5.3.8 Aiming Process**

After establishing their natural alignment, cadets are now ready to move along to the actual sequence of aiming. The aiming process is as follows:

- a. Get into a comfortable position;
- b. Make sure the alignment with the target is good;
- c. Verify the size of the front aperture; and
- d. Follow the procedures described in paragraphs 5.3.5 and 5.3.6.

## **5.4 BREATHING**

### **5.4.1 Importance of Breathing**

Breathing supplies the blood stream with the oxygen necessary for all body functions and to eliminate waste elements (such as carbon dioxide) from the blood. Once a stable position is established, cadets must integrate the principles of breathing. While breathing, the oxygen inhaled is used to supply muscles with energy, ensuring optimal potential of these muscles. This includes the muscles that are involved in the position, as well as the muscles in the eyes.

For maximum stability when firing, cadets will have to stop breathing for a few seconds. It is of the utmost importance that they do not hold their breath for more than five (5) to seven (7) seconds, as the tension will increase in their chest muscles and reduce stability. After this period of time, muscles start to lack oxygen and will quiver and eyesight will be negatively affected. This becomes evident if the cadet’s perception of the aiming mark goes from black to gray.

## 5.4.2 The Breathing Cycle

In order to achieve a proper breathing sequence, the information in the following graph should be adhered to:

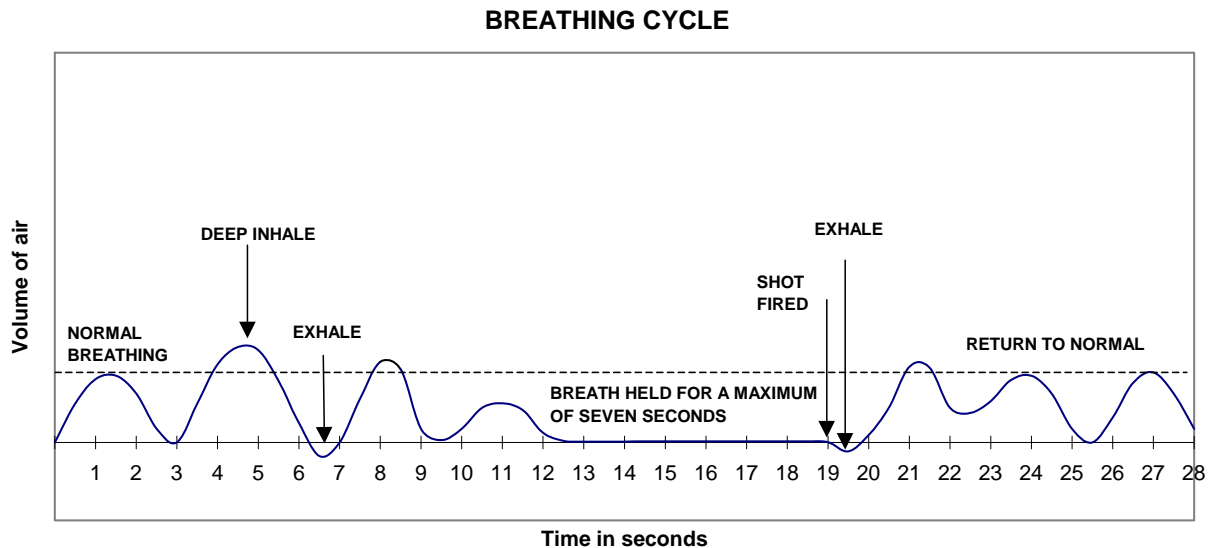

Breathing should be relaxed and normal as cadets establish a sight picture. Then, they should inhale and exhale deeply, take another deep inhale, exhale normally, and completely release their chest muscles and hold their breath. After the shot, a small exhale is followed by normal breathing, and the cycle is repeated.

Cadets should use breathing as a way to confirm that the rifle is moving up and down in a perfect vertical manner and that the rifle is not canted. Also, when breathing in and out, cadets can visually confirm that they are aiming on the proper diagram.

Again, it is important for cadets not to fire if they feel they want to breathe again. Their shot will not be perfect and their end result will be affected. They should not be afraid to restart their entire sequence, as this will only improve their level of performance. Relaxed breathing decreases “vibrations” caused by tension.

## 5.5 TRIGGER CONTROL

### 5.5.1 General

Good trigger control is the second last technical step in carrying out a perfect shot. Consistent squeezing of the trigger assures the desired trajectory upon the departure of the pellet. When incorporated with a proper breathing sequence, trigger control becomes instinctive.

Trigger control is the manipulation of the trigger in such a way that there is no disturbance or motion of the foresight. It must be constant, controlled, slow and deliberate.

### 5.5.2 Controlling Trigger Pressure

The following criteria should be followed when correctly pulling the trigger:

- a. **Position of the Hand on the Rifle.** Cadets should have a relatively firm grip on the small of the butt with the bottom three (3) fingers of their hand. They should not

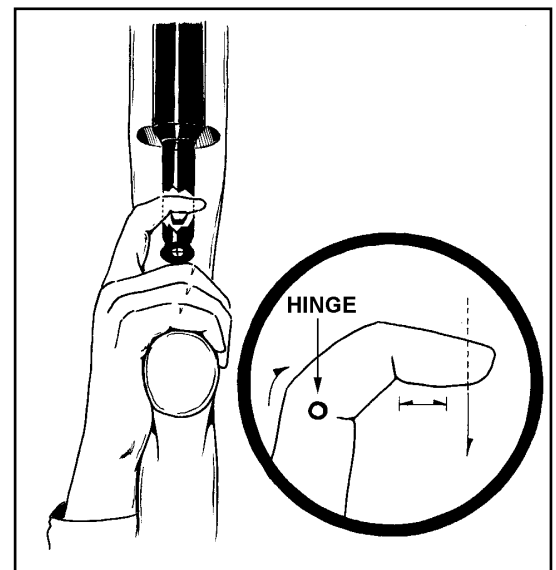

strain their hand and they should make sure the pressure they apply is consistent for every shot. The thumb should point forward and rest in a relaxed position behind the rear sight along the rifle stock or should be wrapped around the small of the butt.

- b. **Trigger Finger Position.** The index finger should be placed on the trigger halfway between the tip of the finger and the first joint. The index finger never touches the stock of the rifle and must be vertically centered on the trigger.

#### **NOTE**

Cadets should remember to always squeeze the trigger.

- c. **Squeezing the Trigger.** Trigger pressure should only be applied when the cadet is ready to fire. It must be applied straight to the rear by bending the second joint of the index finger. Cadets should make sure the pressure they apply is constant and that they slowly squeeze the trigger while they are holding their breath. The trigger of the Daisy 853C has one stage and its weight is not adjustable.

### **5.5.3 Trigger Control Exercises**

An effective trigger control exercise is to simulate the movement by using a clothespin. The clothespin should be split in two. It should be placed on the first joint of the trigger finger and the end of the thumb. Cadets should practice squeezing the clothespin slowly using only one muscle: the one in the index finger. They should then analyze the sensations felt in their hand until they can repeat this sequence when actually firing. None of the other fingers of their hand should move when doing this exercise. This exercise is most effective when done with the eyes open followed by doing it with the eyes closed, so that cadets can concentrate and feel the movement of their trigger finger.

Trigger control can also be mastered by performing dry firing exercises. This technique will be described in details in paragraph 5.9.

## **5.6 FOLLOW-THROUGH**

### **5.6.1 General**

Follow-through is essential to firing perfect shots. It is defined as the act of remaining in position for a few seconds after the pellet's departure and it requires both physical and mental effort. It aids in developing proper hold of the rifle, maintaining stability, ensuring that there is no movement of the rifle as the shot is being fired, and calling the shot after it is fired.

Follow-through is critical with air rifle marksmanship because the slower shot velocity cause the pellet to remain in the barrel for a fraction of a second longer than smallbore or largebore rifles.

If the position is stable, the aiming picture should return to the same place it was before the vibrations caused by the release of compressed air. If this sight picture differs from the initial sight picture, some improvements to the cadet's position need to be done.

## **5.7 LOADING, FIRING AND UNLOADING**

### **5.7.1 Pumping the Air Rifle**

The following guidelines should be adhered to when pumping the air rifle:

- a. Do not pump the rifle more than once per shot. This air rifle is designed to withstand the pressure based on a single pump stroke;

- b. If the air rifle is pumped more than once, or left with a full chamber pressure for an extended period (i.e., one hour), the compressed air may not expel completely upon firing. Consequently, the air rifle may have sufficient pressure remaining in the air pressure chamber to fire another pellet. Therefore, a proper unload drill must be done each time a session of firing is completed; and
- c. The cadet must pump the rifle before loading a pellet.

### **5.7.2 Loading the Air Rifle**

The following steps should be followed when loading the rifle:

- a. Pick up and hold the rifle with the left hand;
- b. Ensure the safety catch is in the ON position;
- c. Place the sling on the rifle;
- d. Pump the rifle. This method can be done effectively in two (2) different ways as outlined in paragraph 5.7.5;
- e. When the pump handle is fully extended, pause for about three (3) seconds (this is very important; if done incorrectly, the rifle will have insufficient air pressure);
- f. Bring the pump lever back to the closed position (watch the fingers!);
- g. Load a pellet or a five (5) pellet clip; and
- h. Close the bolt.

### **5.7.3 Firing the Air Rifle**

The following actions should be performed in order to fire the rifle:

- a. When the RSO gives the command, place the safety catch in the OFF position;
- b. Aim the rifle at the target;
- c. Squeeze the trigger;
- d. Open the bolt, pump the rifle, re-load, aim and fire;
- e. Repeat the last step until the firing is completed;
- f. Upon completion, place the safety catch in the ON position and partially open the pump lever; and
- g. Lay the rifle down.

### **5.7.4 Unloading the Air Rifle**

These steps should be followed when unloading the rifle:

- a. Pick up the rifle;
- b. Remove the five (5) pellet clip (if used);

- c. Pump the rifle (hold for three (3) seconds and close);
- d. Move the bolt forward (do not insert a pellet);
- e. Place the safety catch in the OFF position;
- f. Aim the rifle at the target;
- g. Squeeze the trigger;
- h. Open the bolt;
- i. Place the safety catch in the ON position;
- j. Open the pump lever slightly;
- k. Wait to be cleared by the RSO; and
- l. Lay the rifle down.

### 5.7.5 Pumping the Rifle

There are two (2) effective ways of pumping the rifle. The first and preferred one can be done by the cadet while the second one requires assistance from a coach. Even though the individual method may seem quite awkward, it can be easily performed by any cadet.

To pump the rifle, the cadet should follow these steps:

- a. Remove the butt from the shoulder and rest it on the mat;
- b. Partially open the pump lever with the right hand;
- c. Return the right hand to the small of the butt;
- d. Grasp the pump lever with the left hand, halfway up the lever;
- e. Lift the rifle upwards until the pump lever is fully extended (keep the left elbow on the mat);
- f. Pause for three (3) seconds when the pump lever is fully extended;
- g. Bring the rifle down, thereby returning the pump lever to the closed position;
- h. Load the pellet or the five (5) pellet clip; and
- i. Move the bolt forward.



## 5.8 IMMEDIATE ACTION AND STOPPAGES

When a problem occurs, the cadet must point the rifle down range at all times and notify the RSO. When a problem arises and the barrel needs to be cleared with a safety rod, coaches and RSOs must use extreme caution. They should be careful not to damage the bolt tip or scratch the crown of the barrel by pushing the safety rod through too hard as this could negatively affect the accuracy of the rifle. All pellets that have been cleared with a safety rod should be disposed of.

PROBLEM	SOLUTION
Pellet incorrectly seated in chamber	Place the safety catch in the ON position. Open the bolt fully to the rear. RSO will insert a safety rod in the barrel to clear the pellet.
Pellet stuck in barrel	Place the safety catch in the ON position. Open the bolt fully to the rear. RSO will insert a safety rod in the barrel to clear the pellet.
Two pellets lodged in the barrel or chamber	Attempt twice to fire the pellets out. If unsuccessful: <ol style="list-style-type: none"> <li>Place the safety catch in the ON position;</li> <li>Open the bolt fully to the rear; and</li> <li>RSO will insert a safety rod in the barrel to clear the pellet.</li> </ol>
Rifle does not fire	Conduct a functioning test: <ol style="list-style-type: none"> <li>Place the safety catch in the ON position;</li> <li>Open the bolt fully to the rear;</li> <li>Close the bolt;</li> <li>Place the safety catch in the OFF position; and</li> <li>Squeeze the trigger.</li> </ol> If the rifle still does not fire, conduct a pumping functioning test: <ol style="list-style-type: none"> <li>Place the safety catch in the ON position;</li> <li>Open the bolt fully to the rear;</li> <li>Pump the rifle;</li> <li>Close the bolt;</li> <li>Place the safety catch in the OFF position; and</li> <li>Squeeze the trigger.</li> </ol> If the rifle still does not fire, clear the rifle: <ol style="list-style-type: none"> <li>Place the safety catch in the ON position;</li> <li>Open the bolt fully to the rear and partially open the pump lever; and</li> <li>RSO will insert a safety rod in the barrel to clear the pellet.</li> </ol>
Air escapes from the pump	Replace the o-rings and lubricate the foam wiper ring.
Aperture size is incorrect	There are three (3) aperture sizes and only two (2) concern this type of usage. Use the larger or smaller of the two.
Bolt sticks (malfunction)	Check that the bolt lever is in its proper place. Ensure that there are no pellets stuck in the barrel or chamber.
Butt plate screws are too short	Replace screws with longer ones (#6-32).
Front sight is unstable	Tighten or replace the barrel weight.
Pump friction	Place <b>one</b> (1) drop of oil on the lubricating sponge of the pump.
Rear sight is unstable	Tighten the rear sight screws. Be careful not to strip the screws by over tightening.
Rear sight micrometer will not turn	Replace the sight.
Stock is broken	Replace the stock.

## 5.9 DRY FIRING

There are two (2) methods of dry firing with the Daisy 853C. The first is performed exactly the same way as live firing, except pellets are not used. This method allows the cadet to rehearse all the steps required in operating the rifle.

The second method does not require the rifle to be pumped, but only the action to be cocked. The emphasis here is on position, sight picture and trigger control.

## 5.10 USE OF THE SLING

The sling helps to support most of the weight of the rifle, ensuring minimal muscular effort on the part of the cadet.

### 5.10.1 Assembling the Sling

It is essential that the sling be assembled correctly in order to maintain a comfortable and stable position while firing.

The sling is made up of two (2) sections: a short section and a long section, with two (2) metallic clasps joining the middle. Each clasp has three (3) slots. The shorter end of the sling will go around the arm while the longer end will go on the rifle via the sling swivel. The sling swivel acts as the handstop once the sling is attached to the rifle.

To assemble the sling, follow the steps listed below:

- a. Hold the sling parallel to the ground with the short section in the left hand, ensuring that the rounded tip of the top buckle is pointing left;
- b. Take the short section, loop it up through the middle slot of the metallic clasp and then back down through the front slot (nearest the rounded tip). The short section will now form a circle; and
- c. Turn the sling over and slide the sling swivel onto the long section. Ensure the sling swivel hangs downwards, as it will later attach to the rifle. Loop the long section up through the middle slot and then back down through the front slot. It is now important to take the remaining end and loop it back through the rear slot, locking the sling in place. This will ensure that the sling will not come undone or loosen during firing.

### 5.10.2 Position of the Sling on the Arm

The sling should be positioned on the upper left arm above the biceps near the shoulder. This is the area on the arm where the smallest amount of pulse can be felt. It is held in place either by the rubber pad on the marksmanship jacket or by a strap or hook attached to the jacket. When not wearing a marksmanship jacket, a safety pin can be used to affix the sling to a sweater. The sling should never be twisted. In summary, the sling provides maximum support of the rifle with the least amount of physical effort on the part of the individual.

### 5.10.3 Adjustment of the Sling Swivel

The sling is attached to the sling swivel which lies on the pump handle. The position of the sling swivel is adjustable using a flat-blade screwdriver. It acts as a rest for the cadet's hand and its placement should be adjusted accordingly.

To determine the position of the sling swivel, the following steps are recommended:

- a. Loosen the sling swivel and slide it to the end of the rail;
- b. Have the cadet adopt the prone position **without using the sling**;



- c. Have the cadet aim the rifle down range while placing it securely in the shoulder (ensure the forearm is at least 30° from the ground); and
- d. The point on the fore-end of the stock where the cadet is gripping the stock should be the appropriate sling swivel position. Move the sling swivel to the hand position and tighten it in place using a flat-blade screwdriver.

This gives the cadet a good starting point. If any butt spacers are added on the rifle, the position of the sling swivel should be readjusted.

#### **5.10.4 Adopting the Prone Position Using a Sling**

Steps to adopting the prone position:

- a. Place the sling on the left arm;
- b. Lie down to the left of the rifle;
- c. Attach the sling hook to the sling swivel;
- d. Place the left elbow on the ground;
- e. Pick up the rifle and adjust the sling accordingly;
- f. Get into a comfortable position;
- g. Place the butt plate in the shoulder;
- h. Place the right hand in the small of butt;
- i. Let the right elbow fall to a natural position on the ground;
- j. Place the right cheek on top of the butt; and
- k. Adjust the butt plate length as appropriate.

#### **5.10.5 Attachment of the Sling to the Rifle**

The sling should already be on the cadet's arm for this step. The sling should be attached to the rifle using its hook. To attach the sling, the hook on the sling should be opened by pressing on its side screw. The hook pin should be slipped into the attachment clamp on the rifle's sling swivel and the hook should be screwed over the pin to ensure it will not fall out.

#### **5.10.6 Adjustment of the Sling**

If the sling is too loose it will no longer act as a method of support and the cadet will hold the rifle using their muscles. If the sling is too tight, blood flow will be restricted and cause a more pronounced pulse, which will have a negative effect on the cadet's hold. Therefore, the sling must be comfortable on the arm, providing maximum support, while not clinching the arm.



## SECTION 6

### MARKSMANSHIP TECHNIQUES – STANDING POSITION

This section deals with all the marksmanship skills required for proper firing in the standing position. They can be divided into five principles as follows:

- a. Position;
- b. Holding;
- c. Breathing;
- d. Aiming; and
- e. Trigger control.

These principles must all function in harmony. Improving one while not working on another will not provide very good results in the long run. Perfecting these principles takes time and concentration, cadets should remember – **PRACTICE MAKES PERFECT!**

#### 6.1 THE STANDING POSITION

##### 6.1.1 General

The standing position is the easiest and quickest position to assume and does not require any artificial support like the sling in the prone position. It has the smallest area of support, thus it is the most difficult to hold steady. Cadets must come to grips with the fact that when firing in the standing position, they may never achieve complete immobility.

Obtaining a good position is one of the most, if not the most important principle of marksmanship, especially when firing in the standing position. A good position helps to maintain balance, comfort and stability during the firing session. Although an excellent position will not guarantee an excellent performance, a poor position can almost assure a substantially negative effect on results.

##### 6.1.2 Rifle Rests

An excellent way to practice marksmanship skills required by a cadet is to use a rifle rest such as an adjustable camera stand. This allows the cadet to perfect and to understand their marksmanship skills while the rifle is held steady. Once these skills are learned, the rifle rest should be removed. This technique proves to be very helpful in the standing position since the oscillations of the rifle are amplified due to the lack of support points of the position.

##### 6.1.3 Obtaining a Good Position

The objective of a good position is to obtain a stable, balanced, uniform platform in the most efficient way possible allowing holding and aiming to be achieved with as little movement and muscular tension as possible.

The standing position should be:

- a. Natural;
- b. Without strain;
- c. Comfortable;
- d. Stable;

- e. Balanced in such a way that body weight is equally distributed; and
- f. Consistent throughout the relay.

### 6.1.4 Centre of Gravity

The centre of gravity is the point where the weight of the rifle and the cadet's body weight are evenly distributed between the feet. In order to compensate for the weight of the rifle, the cadet's back is bent rearward and rotated to the left in order to gain bone support and stability.

If the cadet stands straight, the weight of the rifle will pull their body to the front. Muscle strain will appear in the back as the cadet attempts to keep their body from falling forward. By bending backward and rotating the back to the left, a shift in body weight will occur slightly towards the right foot. At a certain point, the weight of the body on the right foot will equal the weight on the left foot. The body-rifle combination then reaches a state of balance, with the centre of gravity located between the cadet's two (2) feet.

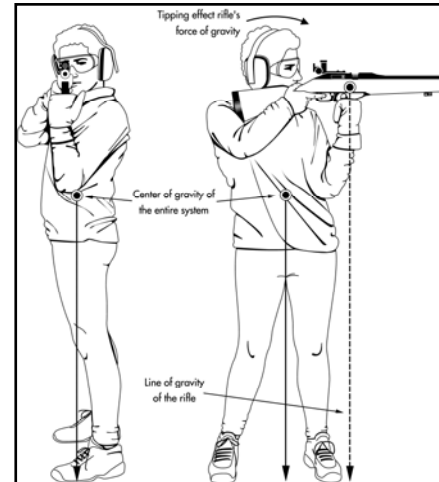

### 6.1.5 Characteristics of a Good Position

The following guidelines should be adhered to when adopting the standing position:

- a. The body should face to the right, approximately 90° to the target;
- b. The feet should be shoulder width apart and cadets should try to stand on the firmest surface possible. They should use comfortable flat sole shoes or boots to add stability to their position;
- c. The weight of the body and the rifle should be equally distributed between the feet;
- d. The feet should point straight ahead in relation to the body or could be turned slightly outward for comfort;
- e. The legs should be straight but not locked as locked knees will affect blood circulation, eventually causing increased discomfort and unsteadiness;
- f. The hips should be 90° to the target and should not thrust forward;
- g. A proper centre of gravity between the body and the rifle should be established. This can be achieved through the use of back bend and body twist. To do this:
  - (1) place the rifle in the shoulder, bend slightly backwards at the waist, ensuring the legs remain straight; and

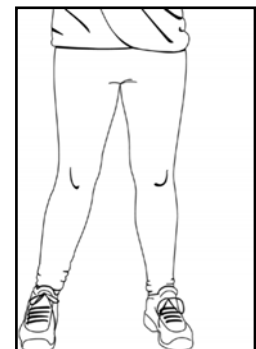
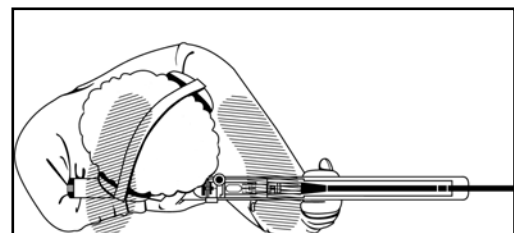

- (2) twist the torso from the small of the back (do not rotate the hips);

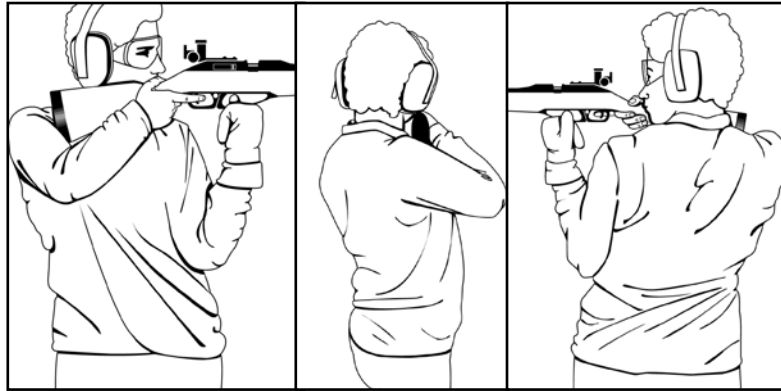

**NOTES**

1. A correctly executed back bend and body twist will result in the weight of the rifle-body mass being supported by the bones of the lower spinal column. Therefore, the standing position utilizes the bones of the body to support the weight of the rifle, not the muscles.
  2. The combination of back bend and body twist is the most important feature of the standing position and will contribute significantly to the cadet's level of performance. However, cadets should understand that discomfort is common during the first few practice sessions. After a short period of time, however, this discomfort will diminish and an increasingly stable hold will be achieved.
- h. The left arm should rest against the rib cage. The left elbow should almost be directly under the rifle. Muscles should not be used to support the left arm. Like the body, the left arm should be placed in a point of balance. The muscles in the left arm must not be used to correct sight alignment;
- i. The left hand is used to support the rifle and should be positioned just forward of the trigger guard. There are several ways of holding the rifle, such as:

- (1) using a clenched fist;



- (2) forming a "V" shape with the thumb and fingers;



- (3) using the “split fingers” technique; and



- (4) using the heel of the hand while keeping the fingers relaxed;

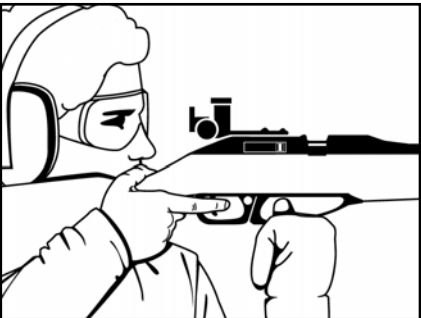

- j. The right hand should be comfortable and under no strain. The right arm should drop naturally to the side. The trigger finger should not touch the stock. The position should allow the right hand, when placed on the pistol grip, to produce a straight back trigger pull;
- k. The head should be in an upright position with the eyes looking forward through the rear sight. To prevent involuntary body sway as a result of the balance mechanism in the inner ear, the head should remain straight and upright. The stock should rest high in the shoulder pocket bringing the sights up to eye level to keep from tipping the head forward to aim. In order to keep the head erect, it may be necessary to slightly cant the rifle to the left. If a cant is required, it is important for the cant to remain the same for every shot;
- 
- l. The head should rest on the cheek piece of the rifle and should not be held up by the neck muscles; and
- m. Eye relief distance should be between 5-15 cm and should usually be slightly greater than in the prone position.

To ensure positive results, the aforementioned points should be repeated for each shot. The feet must always be in the same place, the backbend and body twist must always be consistent, the left elbow must always be in the same place on the rib cage, and the left hand position must always be the same. Also, the head must be levelled and exert the same amount of pressure on the cheek piece, the eye relief must remain constant and the right hand must always be in the same position. If any of these points does not feel right or if the cadet finds the position uncomfortable, their position should be readjusted until it is better.

### 6.1.6 Adopting the Standing Position

Cadets should begin by firing on a rest. After they can attain a tight group, the rest should be removed and cadets should fire on their own. The following steps should be adhered to when adopting the standing position using a rifle rest:

- a. Lay the rifle down on a table;
- b. Stand 90° to the target;
- c. Position the feet shoulder width apart;
- d. Pick up the rifle;
- e. Place the butt plate high in the shoulder pocket;
- f. Position the left hand under the rifle stock;
- g. Lay the right hand on the small of the butt;
- h. Orient the position towards the target;
- i. Lay the rifle on the rest;
- j. Adjust the height of the rest; and
- k. Adjust the length of the butt using spacers.

When not using a rest, the same steps mentioned above should be followed except for point j.

## 6.2 AIMING

### 6.2.1 Front Sight

The front aperture should be selected to provide the best sight picture. A good sized aperture should appear 1-1/2 times bigger than the aiming mark. When firing in the standing position, the larger of the two (2) circular apertures should be used to allow the cadet to better see the aiming mark that will be shifting around more than in the prone position.

### 6.2.2 Rear Sight

#### a. Elevation

To lower the point of impact, turn the elevation knob counterclockwise (to the left). To raise the point of impact, turn the elevation knob clockwise (to the right), as per the arrow and the word "UP".

However, if the rifle is canted to allow the cadet to keep their head leveled, an adjustment for height will move the point of impact in a diagonal line equal to the angle of the rifle's cant. Therefore, when an adjustment for height is made, a lateral adjustment must be made to ensure the point of impact moves in a perfectly vertical manner. For example, when adjusting the sight downward by nine (9) clicks, an additional three (3) clicks to the left may be required to compensate for the cant of the rifle.



**b. Windage**

To move the point of impact to the left, turn the windage knob counterclockwise (to the left). To move the point of impact to the right, turn the windage knob clockwise (to the right), as per the arrow and the letter "R".

Again, as for adjustments in elevation, compensation must be taken into account for the cant of the rifle. For example, when adjusting the sight to the right by six (6) clicks, an additional two (2) clicks downward may be required to compensate for the cant of the rifle.

**Remember: Sight Adjustment**

**UP & RIGHT = clockwise**  
**DOWN & LEFT = counterclockwise**

**If the rifle is canted, sights will also need to be adjusted laterally when being adjusted for height**

**6.2.3 Proper Head Position**

The head should be kept as close as possible to a position which allows the eyes to look straight forward from the eye socket. To illustrate the penalty for not doing this, cadets should try moving their eyes as far in one direction as they can (up, down, right or left) in the eye socket. Instantly they will feel a strain on their eyes. The more their eyes are looking straight forward from the eye socket, the more relaxed their eye muscles will be.

**6.2.4 Eye Relief**

Eye relief is the distance between the eye and the rear sight. Depending on an individual's build and position, this distance is usually 5 to 15 cm. This distance may have to be reduced slightly due to the size of the Daisy 853C rifle. Cadets should strive to achieve an eye relief that is comfortable, natural, and allows them to see a circle of light around the front sight as they look through the rear sight. It is important for them to maintain the same eye relief from shot to shot and to find an eye relief that allows them to keep their head as erect as possible during the firing process. If they get closer than 5 cm from the sight, the line of white around the front sight becomes larger and more difficult to keep aligned.

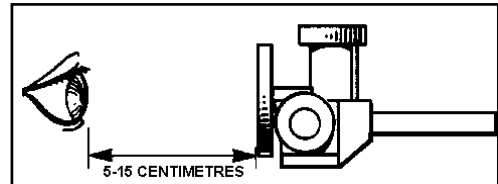

**6.2.5 Sight Alignment**

Sight alignment is the most critical element of the aiming process. It is the alignment of the eye, the rear sight, and the front sight.

When cadets bring their eye 5 to 15 cm from the rear sight, they will find that the small hole is large enough to look through and see all of the front sight. This is what they see when they have achieved proper sight alignment.

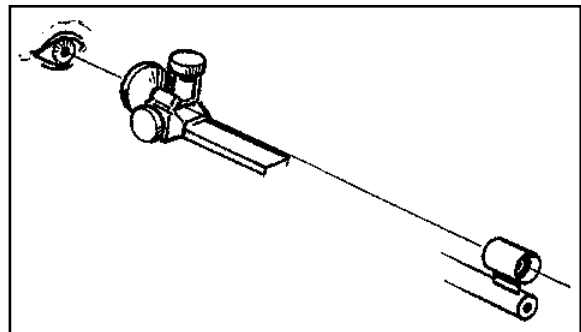



### 6.2.6 Sight Picture

To obtain a proper sight picture, a bullseye is simply added to the innermost ring. The goal during the aiming process is to maintain proper sight alignment while keeping the bull centered in the front sight.

The ultimate goal is to have all the circles in perfect alignment, but even Olympians can only reach this perfection and hold it for no more than a few seconds at a time when firing in the standing position.

Cadets must constantly strive to maintain proper sight alignment, while obtaining a sight picture. It is the most critical element of the aiming process.

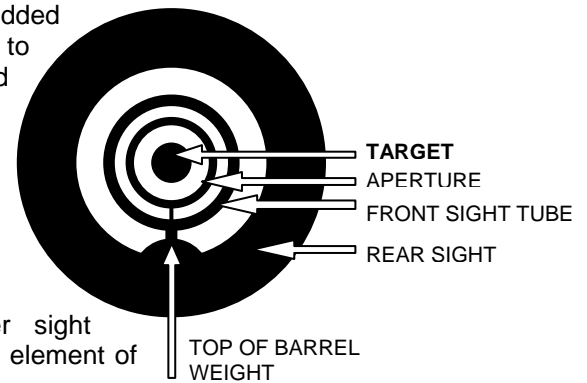

### 6.2.7 Natural Alignment

Natural alignment is obtained when the rifle can be perfectly aimed at the target without being muscled into achieving this. In a comfortable position, the cadet does not force the air rifle to point to the target, which would create muscular tension. Proper alignment will also prevent “drifting” of the group during a course of fire.

After establishing a comfortable position, the cadet must now make sure that their body and rifle are directly aligned with the target. In order to understand the notion of natural alignment it is important to remember that the rifle is supported by the bones and not the muscles.

In order to ensure that the position is directly in line with the target, cadets should follow these steps:

- a. Assume a proper standing position, look through the sights and acquire a proper sight picture;
- b. Close their eyes, take several normal breaths and relax into a comfortable position;
- c. Once comfortable, look through the sights again. If perfectly centered with the target, proceed with firing;
- d. If not directly centered with the target, re-orient the position slightly. To do this, modify the alignment in the following manner:
  - (1) to aim higher, move the left hand position rearward or widen the stance slightly;
  - (2) to aim lower, move the left hand position forward or reduce the size of the stance; and
  - (3) to aim to the left or right, move the feet forwards or backwards in relation to the line of sight; and
- e. Close their eyes and do a final check on their alignment. If not perfectly aligned, they must start over!

Again, it is essential that cadets use their bones to support the rifle, so that their muscles remain relaxed. Under no circumstances should they use their muscles to change the point of aim by moving the rifle from side to side. If they do a proper follow-through, the rifle will automatically return to the point of aim if they are not using muscular force.

It is also important that cadets check their alignment during their course of fire to ensure their position has not shifted. Note also that “warmed” muscle groups react differently from “cold” muscle groups. It is important to allow for a proper warm-up prior to firing. A brief warm-up exercise is described in Section 13.

## 6.2.8 Aiming Process

After establishing their natural alignment, cadets are now ready to move along to the actual sequence of aiming. The aiming process is as follows:

- a. Adopt a comfortable position;
- b. Make sure the alignment with the target is adequate;
- c. Verify the size of the front aperture; and
- d. Follow the procedures described in paragraphs 5.3.5 and 5.3.6.

During the first attempts to fire in the standing position, the rifle will move a great deal. This is normal for a beginner. However, it is important for the cadet to accept these hold movements as normal and to fire the shot without trying to make it absolutely perfect. The diagram below clearly pictures the differences in holding between the prone and standing positions.

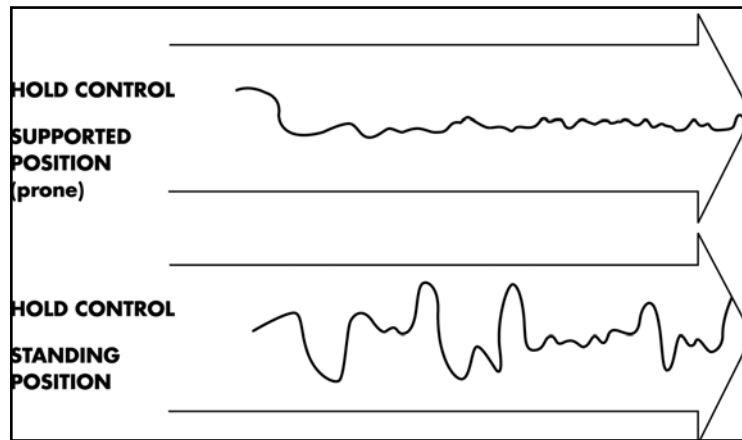

## 6.3 BREATHING

### 6.3.1 Importance of Breathing

Once a stable position is established, cadets must integrate the principles of breathing. While breathing, the oxygen inhaled is used to supply muscles with energy, ensuring optimal potential of these muscles. This includes the muscles that are involved in the position, as well as the muscles in the eyes.

For maximum stability when firing, cadets will have to stop breathing for a few seconds. It is of the utmost importance that they do not hold their breath for more than five (5) to seven (7) seconds, as the tension will increase in their chest muscles and reduce stability. This is of the utmost importance in the standing position as the decrease in stability will be greatly amplified by the lack of contact points with the ground.

### 6.3.2 The Breathing Cycle

In order to achieve a proper breathing sequence, the information in the following graph should be adhered to:

## BREATHING CYCLE

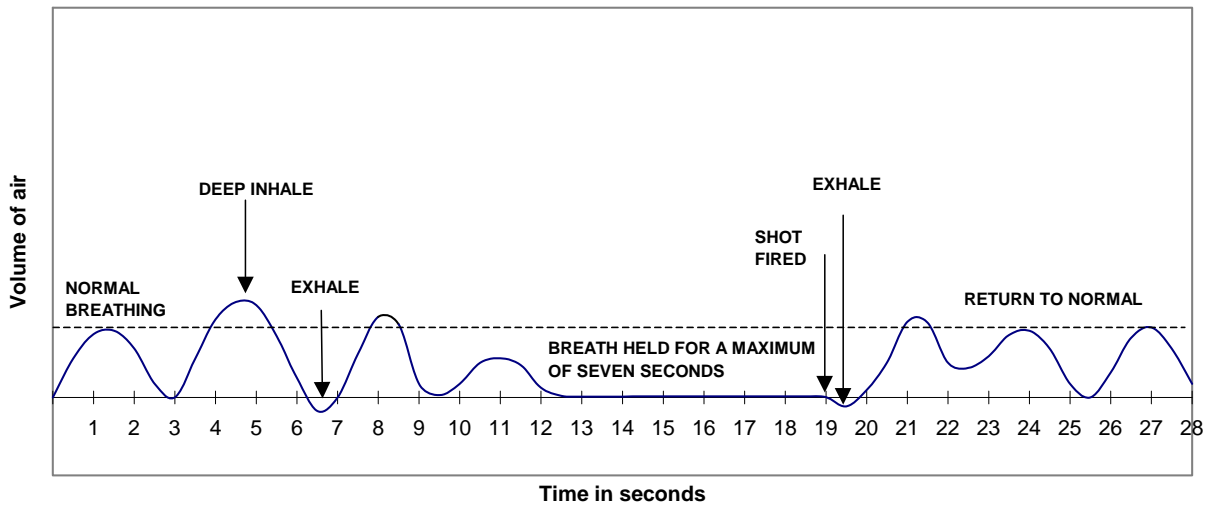

Breathing should be relaxed and normal as cadets establish a sight picture. Then, they should inhale and exhale deeply, take another deep inhale, exhale normally, and completely release their chest muscles and hold their breath. After the shot, a small exhale is followed by normal breathing, and the cycle is repeated.

### 6.4 TRIGGER CONTROL

#### 6.4.1 Controlling Trigger Pressure

The following criteria should be followed when pulling the trigger:

- a. **Position of the Hand on the Rifle.** Cadets should have a relatively firm grip on the small of the butt with the bottom three (3) fingers of their hand. They should not strain their hand and they should make sure the pressure they apply is consistent for every shot. The thumb should point forward and rest in a relaxed position behind the rear sight along the rifle stock or should be wrapped around the small of the butt.
- b. **Trigger Finger Position.** The index finger should be placed on the trigger halfway between the tip of the finger and the first joint. The index finger never touches the stock of the rifle and must be vertically centered on the trigger.
- c. **Squeezing the Trigger**

Trigger pressure should only be applied when the cadet is ready to fire. It must be applied straight to the rear by bending the second joint of the index finger. Cadets should make sure the pressure they apply is constant and that they slowly squeeze the trigger while they are holding their breath. The trigger of the Daisy 853C has one stage and its weight is not adjustable.

Due to the fairly heavy trigger weight of the Daisy 853C and the lesser degree of stability of the standing position, cadets should be slightly more aggressive squeezing the trigger than in the prone position. This means that cadets should still squeeze the trigger gradually, however, doing it in a more rapid fashion since the perfect sight picture will not remain there as long as when firing prone.

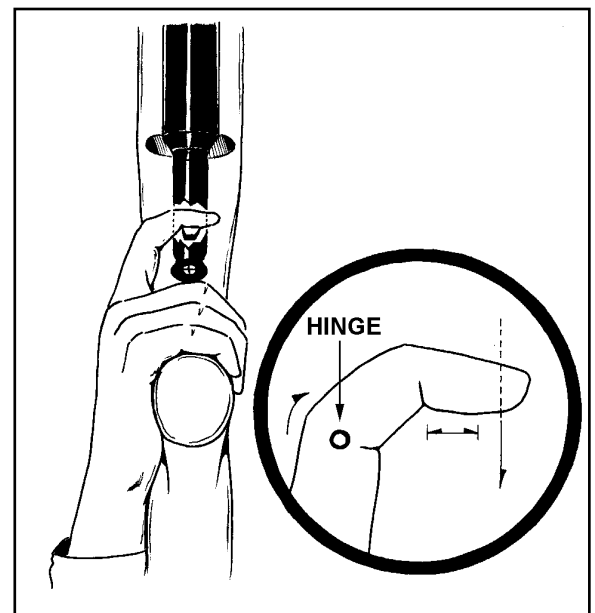

#### NOTE

Cadets should remember to always squeeze the trigger.

## **6.5 FOLLOW-THROUGH**

### **6.5.1 General**

Follow-through is essential to firing perfect shots. It is defined as the act of remaining in position for a few seconds after the pellet's departure and it requires both physical and mental effort. It aids in developing proper hold of the rifle, maintaining stability, ensuring that there is no movement of the rifle as the shot is being fired, and calling the shot after it is fired.

If the position is stable, the aiming picture should return to the same place it was before the vibrations caused by the release of compressed air. If this sight picture differs from the initial sight picture, some improvements to the cadet's position need to be done.

## **6.6 LOADING, FIRING AND UNLOADING**

### **6.6.1 Pumping the Air Rifle**

The following guidelines should be adhered to when pumping the air rifle:

- a. Do not pump the rifle more than once per shot. This air rifle is designed to withstand the pressure based on a single pump stroke;
- b. If the air rifle is pumped more than once, or left with a full chamber pressure for an extended period (i.e., one hour), the compressed air may not expel completely upon firing. Consequently, the air rifle may have sufficient pressure remaining in the air pressure chamber to fire another pellet. Therefore, a proper unload drill must be done each time a session of firing is completed; and
- c. The cadet must pump the rifle before loading a pellet.

### **6.6.2 Loading the Air Rifle**

The following steps should be followed when loading the rifle (the rifle should always point towards the targets):

- a. Pick up and hold the rifle with the left hand;
- b. Ensure the safety catch is in the ON position;
- c. Pump the rifle. This can be done effectively in three (3) different ways as described in paragraph 6.6.5;
- d. When the pump handle is fully extended, pause for about three (3) seconds (this is very important; if done incorrectly, the rifle will have insufficient air pressure);
- e. Bring the pump lever back to the closed position (watch the fingers!);
- f. Load a pellet or a five (5) pellet clip; and
- g. Close the bolt.

### 6.6.3 Firing the Air Rifle

The following actions should be performed in order to fire the rifle (the rifle should always point at the targets):

- a. When the RSO gives the command, place the safety catch in the OFF position;
- b. Aim the rifle at the target;
- c. Squeeze the trigger;
- d. Open the bolt, pump the rifle, re-load, aim and fire;
- e. Repeat the last step until the firing is completed;
- f. Upon completion of the firing, place the safety catch in the ON position and partially open the pump lever; and
- g. Lay the rifle down.

### 6.6.4 Unloading the Air Rifle

These steps should be followed when unloading the rifle (the rifle should always point at the targets):

- a. Pick up the rifle;
- b. Remove the five (5) pellet clip (if used);
- c. Pump the rifle (hold for three (3) seconds and close);
- d. Move the bolt forward (do not insert a pellet);
- e. Place the safety catch in the OFF position;
- f. Aim the rifle at the target;
- g. Squeeze the trigger;
- h. Open the bolt;
- i. Place the safety catch in the ON position;
- j. Open the pump lever slightly;
- k. Wait to be cleared by the RSO; and
- l. Lay the rifle down.

### 6.6.5 Pumping the Air Rifle

To pump the rifle, the cadet should follow these steps:

- a. With the rifle resting on a table, pick up and hold the rifle with the left hand;
- b. Establish a good standing position close enough to the table to allow access to the rifle and equipment placed on the table;

- c. Pump the rifle. This method can be done in three (3) different ways:

**Option 1.** Grasp the pistol grip with the right hand. Grasp the pump handle with the left hand. Push downward with the left hand until the pump handle is fully extended. Wait for a few seconds. Using the left hand, bring the pump handle back to the stock of the rifle. The rifle should remain stationary during the pumping process and always point towards the targets.

**Option 2.** Grasp the pistol grip with the right hand. Grasp the pump handle with the left hand. Place the butt of the rifle under the right arm or shoulder for support. Push downward with the left hand until the pump handle is fully extended. Wait for a few seconds. Using the left hand, bring the pump handle back to the stock of the rifle allowing the underarm and shoulder to help hold the rifle steady when closing the pump handle. Remember that the rifle must always point towards the targets.

**Option 3.** Coach assistance. Point the rifle in a safe direction and request the assistance from a coach. The coach should move in and pump the rifle using both hands. This should be used as a last resort as any cadet can easily do the above two (2) options;

- d. Load the pellet or five (5) pellet clip; and
- e. Move the bolt forward.

## SECTION 7

### MARKSMANSHIP TECHNIQUES – KNEELING POSITION

This section deals with all the marksmanship skills required for firing in the kneeling position. They can be divided into five principles as follows:

- a. Position;
- b. Holding;
- c. Breathing;
- d. Aiming; and
- e. Trigger control.

These principles must all function in harmony. Improving one of the five principles of marksmanship, while not working on another, will not provide very good results in the long run. Perfecting these principles takes time and concentration, cadets should remember – **PRACTICE MAKES PERFECT!**

#### 7.1 THE KNEELING POSITION

##### 7.1.1 General

The kneeling position is a very stable position similar to the prone position, except achieving a comfortable position which is stable and minimizes movement is more difficult to achieve. The kneeling position is characterized by most firers as the least comfortable position and the most difficult to adopt correctly. Slight changes in the position can result in substantial instability, poor performance, and discomfort. Obtaining a good kneeling position takes practice and flexibility, and some discomfort may be experienced by cadets.

The kneeling position uses a sling and contacts the floor at three points:

- a. The kneeling roll and foot combination;
- b. The right knee; and
- c. The left foot.



A correctly adopted kneeling position, combined with substantial practice will result in stability and results similar to the prone position.

##### 7.1.2 Rifle Rests

An excellent way to practice marksmanship skills required by a cadet is to use a rifle rest such as an adjustable camera stand. This allows the cadet to perfect and to understand their marksmanship skills while the rifle is held steady. Once these skills are learned, the rifle rest should be removed.

##### 7.1.3 Obtaining a Good Position

The objective of a good position is to obtain a stable, balanced, uniform platform in the most efficient way possible, while allowing holding and aiming to be achieved with as little movement and muscular tension as possible.

The kneeling position should be:

- a. Natural;
- b. Without strain;
- c. Comfortable;
- d. Stable;
- e. Balanced in such a way that body weight is distributed between the main support points; and
- f. Consistent throughout the relay.

#### 7.1.4 Kneeling Roll

A kneeling roll is a piece of equipment that many firers find improve the stability and comfort of the kneeling position. The main function of the kneeling roll is to provide support under the right foot which the cadet sits upon. The kneeling roll is not always required especially with very flexible shooters. It is recommended cadets attempt the kneeling position using both a kneeling roll and then not using the kneeling roll to determine which method best suits the cadet's body type.

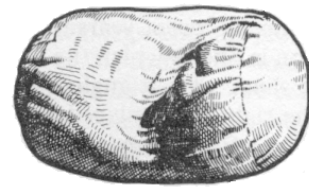

The kneeling roll can be made from various materials like canvas, cotton, or other flexible materials and filled with material which will allow for the roll to form to the cadet's foot. Materials that may be used to fill the kneeling roll are dry beans, small plastic beads, wood chips, or other similar materials. The design of the kneeling roll should allow material to be added or removed as required.

#### 7.1.5 Characteristics of a Good Position

The following guidelines should be adhered to when adopting the kneeling position:

- a. The body should face 30° to 60° to the target, with the left leg pointed in the direction of the target;
- b. The kneeling roll should be placed at the same angle to the target as the right leg. The kneeling roll should be form fitted to the cadet's foot during the preparation stage and before attempting to fine tune the position;
- c. The left foot and kneeling roll will form a straight line to the target;
- d. The right knee is placed on the floor at 30° to 60° to the body with the right foot sitting comfortably into the kneeling roll. Approximately 20% of the body weight is supported by the right knee;

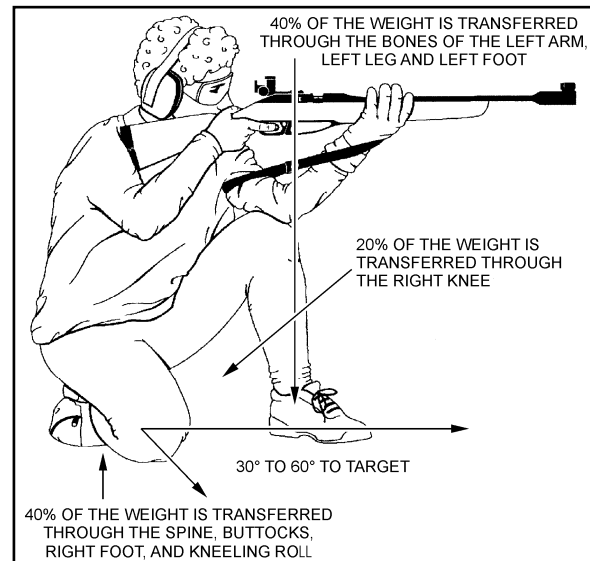



- e. The right heel sits as close to the centre of the buttocks as possible. The right shoe tip sits comfortably on the floor. This combination supports a significant portion of the cadet's weight and this weight is transferred down the spine, into the foot and finally into the kneeling roll. Approximately 40% of the body weight is supported by the kneeling roll and right foot;
- f. The sling is attached to the rifle and the left elbow sits firmly upon the left knee. The combination of the sling, left elbow and rifle form a load-bearing triangle similar to the prone position;
- g. The left hand should rest in the sling and firmly against the sling swivel. The fingers of the left hand should not grip the fore-end of the stock. The hand should be relaxed and the rifle should rest in the palm of the hand;
- h. The placement and subtle position changes of the left foot regulate the natural alignment of the position. By altering the location, angle, and position of the left foot, changes in height and right/left direction can be achieved;
- i. The rifle is placed into the right shoulder and the upper body leans against the rifle, which is held into position with the rifle sling;
- j. The left leg from the knee to the floor is at a 70° to 90° angle to the floor. The left foot is turned towards the right side of the body to improve stability of the left leg. Approximately 40% of the body weight is supported by the left leg;
- k. The shoulders should be straight and form right angles with the spine;
- l. The butt plate is kept firmly in the hollow of the right shoulder. In order to ensure that the butt plate is always placed in the same spot, cadets should grasp it with their thumb and forefinger and place it in their shoulder for each and every shot;
- m. The right arm should fall comfortably and naturally to the side of the body and the right hand should be placed upon the small of the butt. The right hand should be comfortable and under no strain. The trigger finger should not touch the stock. The position should allow the right hand, when placed on the small of the butt, to produce a straight back trigger pull;
- n. The head rests comfortably on the cheek piece and remains straight and level. There should be a minimal distance of approximately five (5) cm between the right eye and the rear sight (known as eye relief). This distance should remain constant throughout the relay. When the face is placed on the cheek piece, the cadet should be looking directly through the sights. If this is not the case, their position should be modified; and
- o. To assist with firing in the kneeling position, cadets should use a chair or adjusting device to place their pellets, and equipment. The chair or adjusting device eliminates the requirement to move the position to reach for targets, pellets or other equipment during a course of fire. The chair or adjusting device cannot provide any type of artificial support.

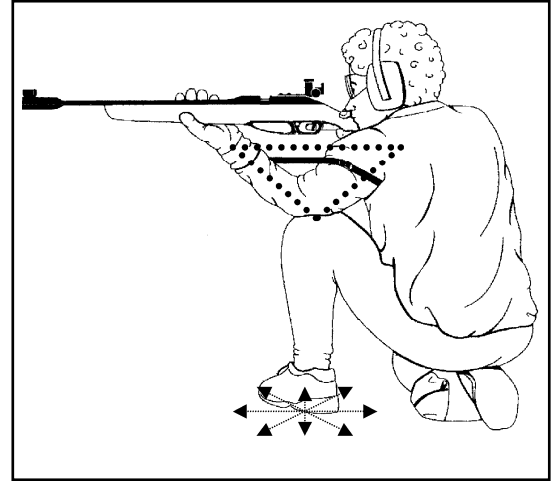

To ensure positive results, the aforementioned points should be repeated for each shot. The position and weight distribution of the left leg, right knee, right foot and kneeling roll must remain the same. The head must be levelled and exert the same amount of pressure on the cheek piece, the eye relief must remain constant and the right hand must always be in the same position. If any of these points do not feel right or if the cadet finds the position uncomfortable, the position should be adjusted until the condition is improved.

## **7.2 USE OF THE SLING**

The sling acts to support most of the weight of the rifle and some of the upper body when in the kneeling position. The sling ensures minimal muscular effort on the part of the cadet when firing.

### **7.2.1 Assembling the Sling**

It is essential that the sling be assembled correctly in order to maintain a comfortable and stable position while firing in the kneeling position.

The sling is made up of two (2) sections; a short section and a long section, with two (2) metallic clasps joining in the middle. Each clasp has three (3) slots. The shorter end of the sling will go around the arm while the longer end will go on the rifle via the sling swivel. The sling swivel acts as the handstop once the sling is attached to the rifle.

To assemble the sling, follow the steps listed below:

- a. Hold the sling parallel to the ground with the short section in the left hand, ensuring that the rounded tip of the top buckle is pointing left;
- b. Take the short section, loop it up through the middle slot of the metallic clasp and then back down through the front slot (nearest the rounded tip). The short section will now form a circle; and
- c. Turn the sling over and slide the sling swivel onto the long section. Ensure the sling swivel hangs downwards, as it will later attach to the rifle. Loop the long section up through the middle slot and then back down through the front slot. It is now important to take the remaining end and loop it back through the rear slot, locking the sling in place. This will ensure that the sling will not come undone or loosen during firing.

### **7.2.2 Position of the Sling on the Arm**

The slings should be positioned on the upper left arm above the bicep near the shoulder. This is the area on the arm where the smallest amount of pulse can be felt. It is held in place either by the rubber pad on the marksmanship jacket or by a strap or hook attached to the jacket. When not wearing a marksmanship jacket, a safety pin can be used to affix the sling to a sweater. The sling should never be twisted. In summary, the sling provides maximum support of the rifle with the least amount of physical effort on the part of the individual.

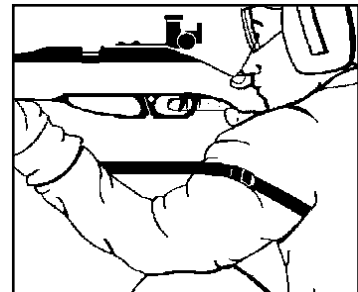

### **7.2.3 Adjustment of the Sling Swivel**

The sling is attached to the sling swivel which lies on the pump handle. The position of the sling swivel is adjustable using a flat-blade screwdriver. It acts as a rest for the cadet's hand and its placement should be adjusted accordingly.

To determine the position of the sling swivel, the following steps are recommended:

- a. Loosen the sling swivel and slide it to the end of the rail;

- b. Have the cadet adopt the kneeling position without using the sling;
- c. Have the cadet aim the rifle down range while placing it securely in the shoulder; and
- d. The point on the fore-end of the stock where the cadet is gripping the stock should be the appropriate sling swivel position. Move the sling swivel to the hand position and tighten it in place using a flat-blade screwdriver.

This gives the cadet a good starting point. If any butt spaces are added on the rifle, the position of the sling swivel should be adjusted.

#### **7.2.4 Adopting the Kneeling Position Using a Sling**

Steps to adopting the kneeling position:

- a. Place the sling on the left arm;
- b. Adopt the kneeling position to the left of the rifle as described in paragraph 7.1.5;
- c. Pickup the rifle and attach the sling hook to the sling swivel while ensuring the rifle is pointed down range;
- d. Place the left elbow upon the left knee ensuring the rifle is pointed down range. Adjust the sling accordingly;
- e. Get into a comfortable position;
- f. Place the butt plate in the shoulder;
- g. Place the right hand in the small of the butt;
- h. Let the right elbow fall to a natural position beside the body;
- i. Place the right cheek on top of the butt; and
- j. Adjust the butt plate length as appropriate.

#### **7.2.5 Attachment of the Sling to the Rifle**

The sling should already be on the cadet's arm for this step. The sling should be attached to the rifle using its hook. To attach the sling, the hook on the sling should be opened by pressing on its side screw. The hook pin should be slipped into the attachment clamp on the rifle's sling swivel and the hook should be screwed over the pin to ensure it will not fall out.

#### **7.2.6 Adjustment of the Sling**

If the sling is too loose it will no longer act as a method of support and the cadet will hold the rifle using their muscles. If the sling is too tight, blood flow will be restricted and cause a more pronounced pulse, which will have a negative effect on the cadet's hold. Therefore, the sling must be comfortable on the arm, providing maximum support, while not clinching the arm.

### 7.3 AIMING

#### 7.3.1 Front Sight

The front aperture should be selected to provide the best sight picture. A good sized aperture should appear 1-1/2 times bigger than the aiming mark. When firing in the kneeling position, most shooters find the aperture used in the prone position is used in the kneeling position.

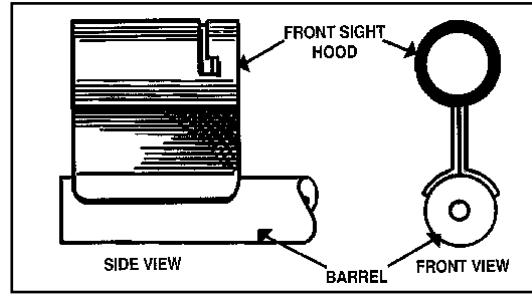

#### 7.3.2 Rear Sight

The part of the rear sight that is looked through is the peep sight. It is a small disk about the size of a penny with a small hole in the middle.

The rear sight has two (2) knobs that are used to move the point of impact of the shot. The adjustment of the knobs is measured in clicks that can be felt as the knob is turned. It takes three (3) clicks to move the point of impact approximately one pellet width. At a distance of ten (10) metres, each click equals approximately a 1.219-mm shift of the point of impact.

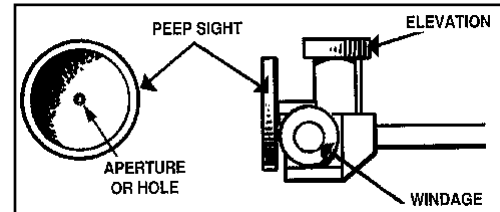

- a. **Elevation.** To lower the point of impact, turn the elevation knob counterclockwise (to the left). To raise the point of impact, turn the elevation knob clockwise (to the right), as per the arrow and the word "UP" which is written on the elevation knob.
- b. **Windage.** To move the point of impact to the left, turn the windage knob counterclockwise (to the left). To move the point of impact to the right, turn the windage knob clockwise (to the right), as per the arrow and the letter "R" which is written on the windage knob.

**Remember: Sight Adjustment**

**UP & RIGHT = clockwise**  
**DOWN & LEFT = counterclockwise**

#### 7.3.3 Proper Head Position

The head should be kept as close as possible to a position which allows the eyes to look straightforward from the eye sockets. It is acceptable for the head to tilt forward slightly, but cadets must resist allowing the head to tilt to the left or right as this affects their sense of balance.

#### 7.3.4 Eye Relief

Eye relief is the distance between the eye and the rear sight. Depending on the individual's build and position, this distance is usually 5 to 15 cm. This distance may have to be reduced slightly due to the size of the Daisy 853C air rifle. Cadets should strive to achieve an eye relief that is comfortable, natural, and allows them to see a circle of light around the front sight as they look through the rear sight. It is important for them to maintain the same eye relief from shot to shot and to find an eye relief that allows them to keep their head as erect as possible during the firing process. If they get closer than 5 cm from the sight, the line of white around the front sight becomes larger and more difficult to keep aligned.

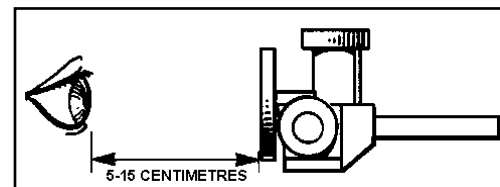

### 7.3.5 Sight Alignment

Sight alignment is the most critical element of the aiming process. Sight alignment is the alignment of the eye, the rear sight, and the front sight with the target.

When cadets bring their eye 5 to 15 cm from the rear sight, they will find that the small hole is large enough to look through and see all of the front sight. This is what they see when they have achieved proper sight alignment.

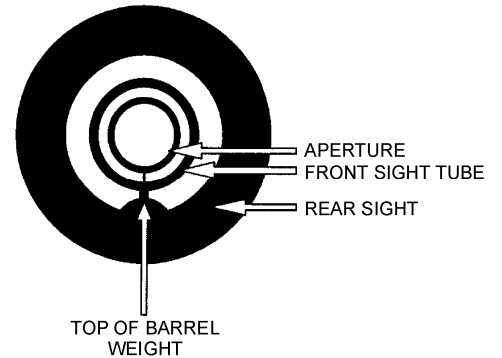
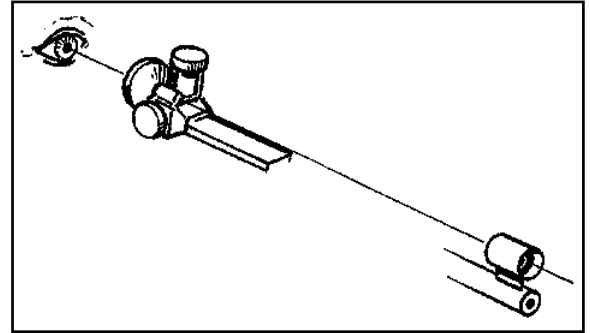

### 7.3.6 Sight Picture

To obtain a proper sight picture, simply align the target to the innermost ring. The goal during the aiming process is to maintain proper sight alignment while keeping the target centered in the front sight.

The ultimate goal is to have all the circles in perfect alignment, but even Olympians can only reach this perfection and hold it for no more than a few seconds at a time when firing.

Cadets must constantly strive to maintain proper sight alignment, while obtaining a sight picture. It is the most critical element of the aiming process.

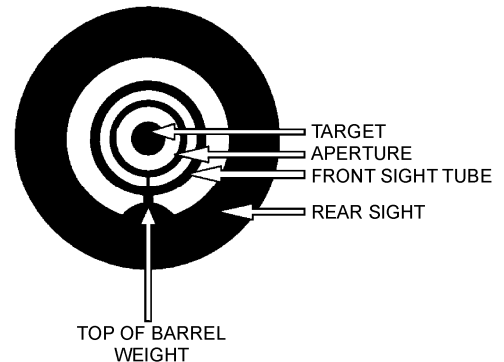

### 7.3.7 Natural Alignment

Natural alignment is obtained when the rifle can be perfectly aimed at the target without being muscled into achieving this. In a comfortable position, the cadet does not force the air rifle to point to the target, which would create muscular tension. Proper alignment will also prevent "drifting" of the group during a course of fire.

After establishing a comfortable position, the cadet must now make sure that their body and rifle are directly aligned with the target. In order to understand this notion of natural alignment it is important to remember that the rifle is supported by the bones of the body and not by the muscles.

In order to ensure that the position is directly in line with the target, cadets should follow these steps:

- a. Assume a proper kneeling position, look through the sights and acquire a proper sight picture;
- b. Close both eyes, take several normal breaths and relax into a comfortable position;

- c. Once comfortable, look through the sights again. If perfectly centered with the target, proceed with firing;
- d. If not directly centered with the target, re-orient the position; and
- e. Close their eyes and do a final check on their alignment. If not perfectly aligned, they must continue to adjust their position.

Again, it is essential that cadets use their bones to support the rifle, so that their muscles remain relaxed. Under no circumstances should they use their muscles to change the point of aim by moving the rifle from side to side. If they do a proper follow-through, the rifle will automatically return to the natural point of aim if they are not using muscular force.

It is important that cadets check their alignment during their course of fire to ensure their position has not shifted. Note also, "warmed" muscles groups react differently from "cold" muscle groups. It is important to allow for a proper warm-up prior to firing. A brief warm-up exercise is described in Section 14.

### 7.3.8 Aiming Process

After establishing their natural alignment, cadets are now ready to move along to the actual sequence of aiming. The aiming process is as follows:

- a. Adopt a comfortable position;
- b. Make sure the alignment with the target is adequate;
- c. Verify the size of the front aperture; and
- d. Follow the procedures described in paragraphs 7.3.5 and 7.3.6.

During the first attempts to fire in the kneeling position, the rifle will move. This is normal for a beginner.

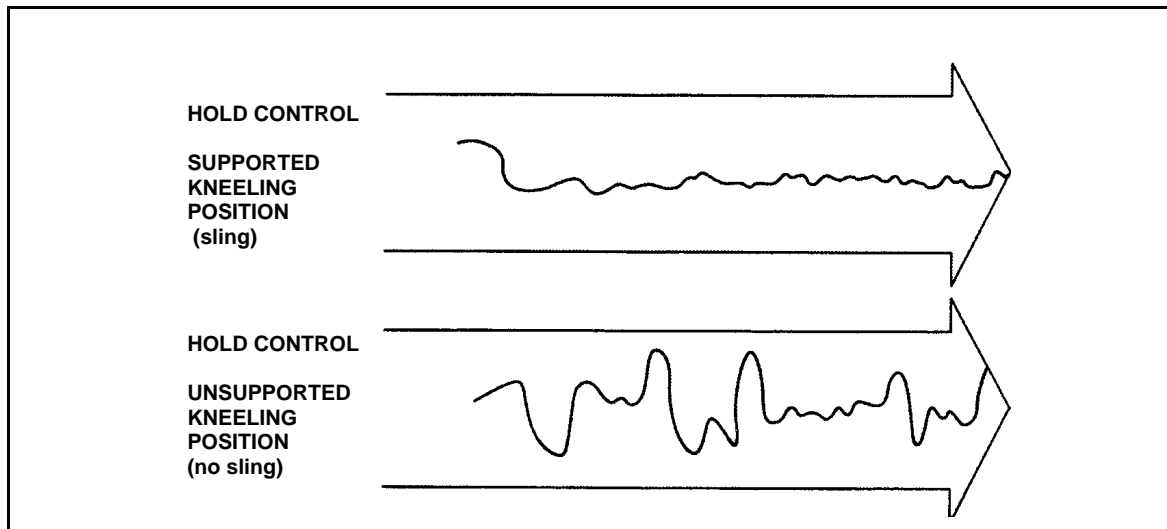

## 7.4 BREATHING

### 7.4.1 Importance of Breathing

Once a stable position is established, cadets must integrate the principles of breathing. While breathing, the oxygen inhaled is used to supply muscles with energy, ensuring optimal potential of these muscles. This includes the muscles that are involved in the position, as well as the muscles in the eyes.

For maximum stability when firing, cadets will have to stop breathing for a few seconds. It is of the utmost importance that they do not hold their breath for more than seven (7) seconds, as the tension will increase in their chest muscles and reduce stability.

### 7.4.2 The Breathing Cycle

In order to achieve a proper breathing sequence, the information in the following graph should be adhered to:

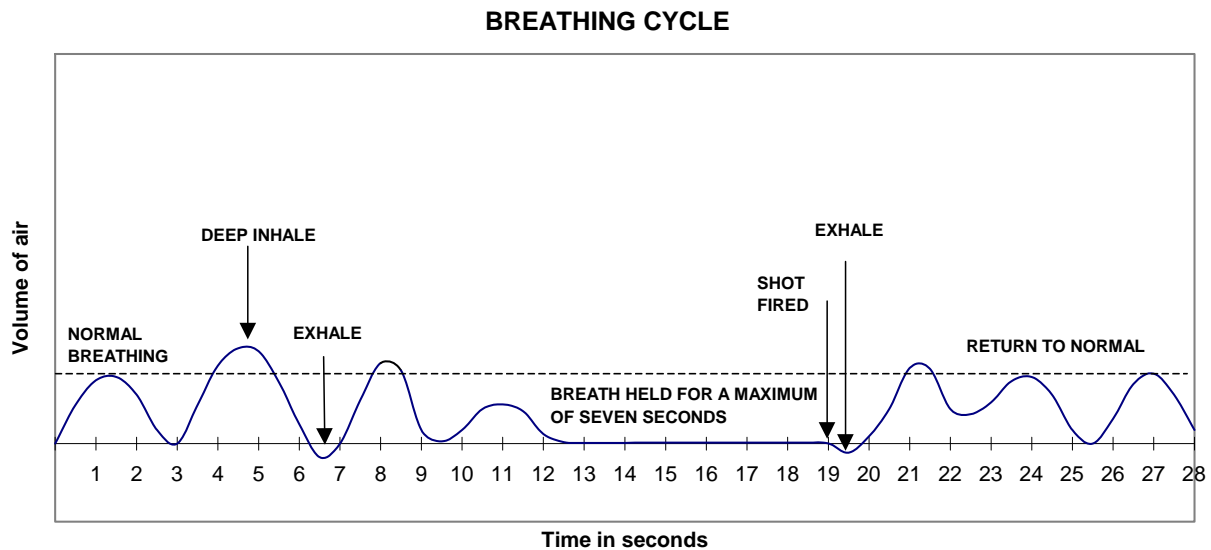

Breathing should be relaxed and normal as cadets establish a sight picture. Then, they should inhale and exhale deeply, take another deep inhale, exhale normally, and completely release their chest muscles and hold their breath. After the shot, a small exhale is followed by normal breathing, and the cycle is repeated.

## 7.5 TRIGGER CONTROL

### 7.5.1 Controlling Trigger Pressure

The following criteria should be followed when squeezing the trigger:

- a. **Position of the Hand on the Rifle.** Cadets should have a relatively firm grip on the small of the butt with the bottom three (3) fingers of their hand. They should not strain their hand and they should make sure the pressure they apply is consistent for every shot. The thumb should point forward and rest in a relaxed position behind the rear sight along the rifle stock or should wrap around the small of the butt.

- b. **Trigger Finger Position.** The index finger should be placed on the trigger halfway between the tip of the finger and the first joint. The index finger never touches the stock of the rifle and must be vertically centered on the trigger.
- c. **Squeezing the Trigger.** Trigger pressure should only be applied when the cadet is ready to fire. It must be applied straight to the rear by bending the second joint of the index finger. Cadets should make sure the pressure they apply is constant and that they slowly squeeze the trigger while they are holding their breath. The trigger of the Daisy 853C air rifle has one stage and its weight is not adjustable.

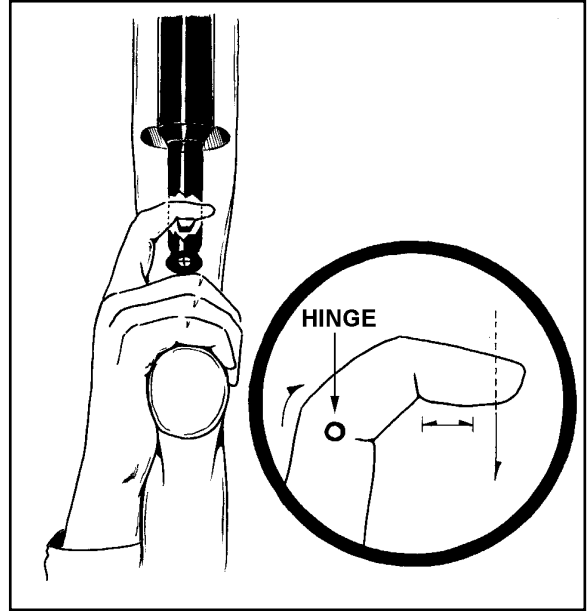

## 7.6 FOLLOW-THROUGH

### 7.6.1 General

Follow-through is essential to firing perfect shots. It is defined as the act of remaining in position for a few seconds after the pellet's departure and it requires both physical and mental effort. It aids in developing proper hold of the rifle, maintaining stability, ensuring that there is no movement of the rifle as the shot is being fired, and calling the shot after it is fired.

If the position is stable, the aiming picture should return to the same place it was before the vibrations caused by the release of compressed air. If this sight picture differs from the initial sight picture, some improvements to the cadet's position need to be done.

## 7.7 LOADING, FIRING AND UNLOADING

### 7.7.1 Pumping the Air Rifle

The following guidelines should be adhered to when pumping the air rifle:

- a. Do not pump the rifle more than once per shot. This air rifle is designed to withstand the pressure based upon a single pump stroke;
- b. If the air rifle is pumped more than once, or left with a full chamber pressure for an extended period (i.e., one hour), the compressed air may not expel completely upon firing. Consequently, the air rifle may have sufficient pressure remaining in the air pressure chamber to fire another pellet. Therefore, a proper unload drill must be done each time a session of firing is completed; and
- c. The cadet must pump the rifle before loading a pellet.

### 7.7.2 Loading the Air Rifle

The following steps should be followed when loading the rifle (the rifle should always point toward the target):

- a. Pick up and hold the rifle with the left hand;
- b. Ensure the safety catch is in the ON position;
- c. Pump the rifle. This can be done effectively in two (2) different ways as described in paragraph 7.7.5;
- d. When the pump handle is fully extended, pause for about three (3) seconds (this is very important; if done incorrectly, the rifle will have insufficient air pressure);



- e. Bring the pump lever back to the closed position (watch the fingers!);
- f. Load a pellet or a five (5) pellet clip; and
- g. Close the bolt.

### **7.7.3 Firing the Air Rifle**

The following actions should be performed in order to fire the rifle (the rifle should always point at the target):

- a. When the RSO gives the command, place the safety catch in the OFF position;
- b. Aim the rifle at the target;
- c. Squeeze the trigger;
- d. Open the bolt, pump the rifle, re-load, aim and fire;
- e. Repeat the last step until firing is completed;
- f. Upon completion, open the bolt, place the safety catch in the ON position and partially open the pump lever; and
- g. Lay the rifle down.

### **7.7.4 Unloading the Air Rifle and Preparing for Inspection**

These steps should be followed when unloading the rifle (the rifle should always point at the target):

- a. Pick up the rifle;
- b. Remove the five (5) pellet clip (if used);
- c. Pump the rifle (hold for three (3) seconds and close);
- d. Move the bolt forward (do not insert a pellet);
- e. Place the safety catch in the OFF position;
- f. Aim the rifle at the target;
- g. Squeeze the trigger;
- h. Open the bolt;
- i. Place the safety catch in the ON position;
- j. Open the pump lever slightly;
- k. Place the rifle on the shoulder, muzzle pointed down range;
- l. Wait to be cleared by the RSO; and
- m. Lay the rifle down.

### 7.7.5 Pumping the Air Rifle

There are two (2) effective ways of pumping the rifle. The first and preferred one can be done by the cadet while the second one requires assistance from a coach. Even though the individual method may seem difficult and complicated, it can be easily performed by any cadet.

To pump the rifle, the cadet should follow these steps:

- a. Remove the butt from the shoulder and ensure a firm grip on the rifle;
- b. Partially open the pump lever with the right hand;
- c. Return the right hand to the small of the butt;
- d. Grasp the pump lever with the left hand, halfway up the lever;
- e. Lift the rifle upwards until the pump lever is fully extended (keep the left elbow in position on the left knee);
- f. Pause for three (3) seconds when the pump lever is fully extended;
- g. Bring the rifle down, thereby returning the pump lever to the closed position;
- h. Load the pellet or the five (5) pellet clip; and
- i. Move the bolt forward.

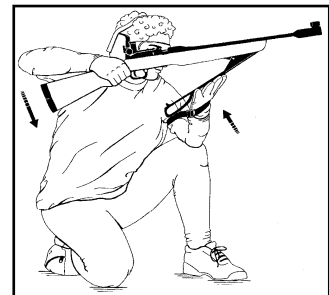

## SECTION 8

### RANGES AND RANGE PROCEDURES

#### 8.1 GENERAL SAFETY

Air rifles may only be fired on a properly prepared air rifle range. The principle dangers found on an air rifle range are:

- a. The ricochet of pellets after they strike a reflecting surface; and
- b. Improper firearms handling.

It is the responsibility of the RSO to ensure that the range is safe and meets all range requirements. It is essential that no part of the pellet stop area may cause a pellet to ricochet.

Each cadet should be provided an area 1.25 metres wide and 2.5 metres (8.2 ft) long when firing in the prone position.

#### 8.2 PORTABLE RANGE SET-UP AND MAINTENANCE

The marksmanship CATO, specifically the annexes on ranges and security should be consulted for all the technical details relevant to this chapter.

##### 8.2.1 General

The following items are required to set up a portable air rifle range:

- a. Area 15 metres long with controlled access;
- b. Numbered target backstops and firing lanes;
- c. Flags (red and green);
- d. First aid kit and stretcher;
- e. Clock and stopwatch (required for competitions);
- f. Appropriate mats;
- g. Spotting scopes;
- h. Hearing protectors;
- i. Safety glasses;
- j. Targets;
- k. Pellets; and
- l. Hand washing facility.

### **8.2.2 RSO Duties**

The RSO must accomplish the following duties:

- a. Prepare the range;
- b. Inspect the range for possible hazards;
- c. Ensure the firing line is ten (10) metres from the targets;
- d. Task and brief range staff;
- e. Control required flags or control lights, and sentries;
- f. Ensure administration requirements are met (i.e., rations and ammunition); and
- g. Fill logbook and registers as required.

#### **NOTE**

See Air Rifle RSO Course Precis for further instructions on range set-up/conduct.

### **8.2.3 Backstops**

There are two (2) possible types of backstop:

- a. Portable target backstops; and
- b. Permanent range backstops.

### **8.2.4 Maintenance**

The range must be cleaned after each use and the lead disposed of as hazardous waste. The pellet stop must be inspected regularly to ensure that deterioration has not occurred.

### **8.3 RANGE TYPES**

The following range types may be used:

- a. Existing indoor ranges;
- b. Temporary indoor ranges;
- c. Existing outdoor ranges; and
- d. Temporary outdoor ranges.

#### **NOTE**

When outdoor ranges are used, environmental effects (in particular wind) must be taken into consideration.

### 8.3.1 Existing Indoor Ranges

Please note that indoor ranges that are not certified for support of smallbore firearms may still be used with air rifles. Air rifles do not use primers or propellants, which are the main source of lead contamination for indoor ranges. The appropriate range certifying authority should be consulted in advance to prevent misunderstandings.

### 8.3.2 Temporary Indoor Ranges

Any room or building exceeding 15 metres in length may be adapted to become a temporary air rifle range (see appropriate CATO).

### 8.3.3 Existing Outdoor Ranges

The following precautions will be observed when firing air rifles on open outdoor ranges:

- a. The target area backstop and sidewalls (if required) will be three (3) metres high; and
- b. The danger area template will be 250 metres in depth and extend 50 mils (2.8°) from the centre line of each firing point.

### 8.3.4 Temporary Outdoor Ranges

Enclosed temporary outdoor ranges constructed from modular tenting may be used. Open temporary outdoor ranges must have a danger area template of 250 metres in depth and extend 50 mils (2.8 degrees) from the centre line of each firing position.

## 8.4 RANGE COMMANDS AND PROCEDURES

### 8.4.1 Range Commands

The following range commands will be given by the RSO and must be learned by cadets before they fire on a range:

COMMAND	ACTION
<b>“Cover off your firing point”</b>	Stand up, move behind the firing point and await further commands.
<b>“Place your equipment down and stand back”</b>	Lay the equipment down on the mat and stand back when finished.
<b>“Adopt the prone position”</b>	Adopt the prone position, pick up the rifle, ready the equipment and put on hearing and eye protection.
<b>Type of firing</b>	This command includes information about the range and type of firing. i.e., Relay #__, ten (10) metres, five (5) rounds, Grouping, On Your Own Time...

COMMAND	ACTION
<b>“Relay, load, commence firing”</b>	Pick up and hold the rifle with the left hand; Ensure the safety catch is in the ON position; Pump the rifle; When the pump lever is fully extended, pause for about three (3) seconds; Load the pellet; Close the bolt; Place the safety catch in the OFF position; Aim the rifle at the target. Squeeze the trigger; Open the bolt; Repeat the sequence for each shot; Place the safety catch in the ON position and partially open the pump lever immediately after firing the practice; and Lay down the rifle.
<b>MAY BE GIVEN</b>	
<b>“Relay, cease fire”</b>	Stop firing immediately, put the safety catch in the ON position and lay the rifle down.
<b>“Relay, resume fire”</b>	Put the safety in the OFF position and continue the practice.
<b>“Relay, unload and prepare for inspection”</b>	Pick up the rifle; Remove the five (5) pellet clip if used; Pump the rifle; Close the bolt; Place the safety catch in the OFF position; Aim rifle at target; Pull the trigger; Open the bolt; Place safety catch in the ON position; Open the pump lever 5-8 cm; Place the rifle on the shoulder, muzzle pointed down range; Wait to be cleared by the RSO; Lay the rifle down; and Remove your hearing and eye protection.
<b>“Relay, stand up”</b>	Stand up and leave the equipment on the ground.
<b>“Change targets”</b>	Move forward, walk down the lane to remove old targets and replace them with new ones. Return to the firing point.
<b>“Change relays”</b>	Cadets who have just fired pick up their personal equipment and move off the firing point. The new relay covers off behind the firing point.

## SECTION 9

### TARGET AND SCORING

#### 9.1 TARGETS

##### 9.1.1 General

Pellets will only be fired at penetrable or light reactive targets designed uniquely for use with air rifle pellets.

Penetrable or paper targets are to be mounted on a soft penetrable board, such as Bristol board or cardboard box material. Large head pins must not be used to secure targets as pellets may deflect off them or shatter the pinheads. Tape, elastics or light small head pins should be used to mount penetrable targets. Targets should be placed at the same level as the individual's shoulder or head.

The distance from the forward edge of the firing point line to the target edge line will be ten (10) metres. No portion of the cadet's body may touch the ground in front of the firing line.

##### 9.1.2 Approved DND Targets

The following are approved DND targets for air rifle use:

- a. Paper penetrable grouping and scoring targets;
- b. Biathlon Canada approved reactive targets;
- c. Competition targets including paper penetrable targets or light reactive targets for use in competitions supported by the Canadian Cadet Movement, the Dominion of Canada Rifle Association (DCRA), the Shooting Federation of Canada (SFC) or their affiliates; and
- d. Light reactive targets such as falling plates, spinners or similar devices when approved by the Regional Marksmanship Officer.

#### 9.2 SCORING

##### 9.2.1 General

The following points must be taken into account when scoring a target:

- a. All shot holes are scored according to the highest value of the ring that is touched by the hole. If two (2) scoring rings are touched, the pellet must be scored at the higher value of the two (2) rings;
- b. Hits outside the scoring rings are scored as misses and are given a value of zero (0); and
- c. If the value of a shot is in dispute, the value is determined by means of a scoring template, magnifier or scoring plug.

##### 9.2.2 Scoring Devices

There are four types of scoring devices currently in use in the CCM:

- a. Grouping template;
- b. Scoring magnifier;

- c. Scoring plug; and
- d. Scoring template.

### Grouping Template (see Annex B)

A grouping template is a series of grouping circles engraved or printed on transparent material. It is used to confirm the diameter of a grouping fired during familiarization or classification firing. The grouping template consists of two (2) parts:

- a. a series of grouping circle outlines, with diameters from one (1) cm to six (6) cm inclusive; and
- b. an outline of an air rifle application target that may be superimposed over a grouping so that a score may be assessed.

It is very important to correctly and consistently measure grouping targets with the grouping template. When evaluating grouping targets, all five (5) shots must lay inside the grouping circle being evaluated. If the group touches the grouping circle, the next sized circle should be used until all five (5) shots lay inside the grouping circle.

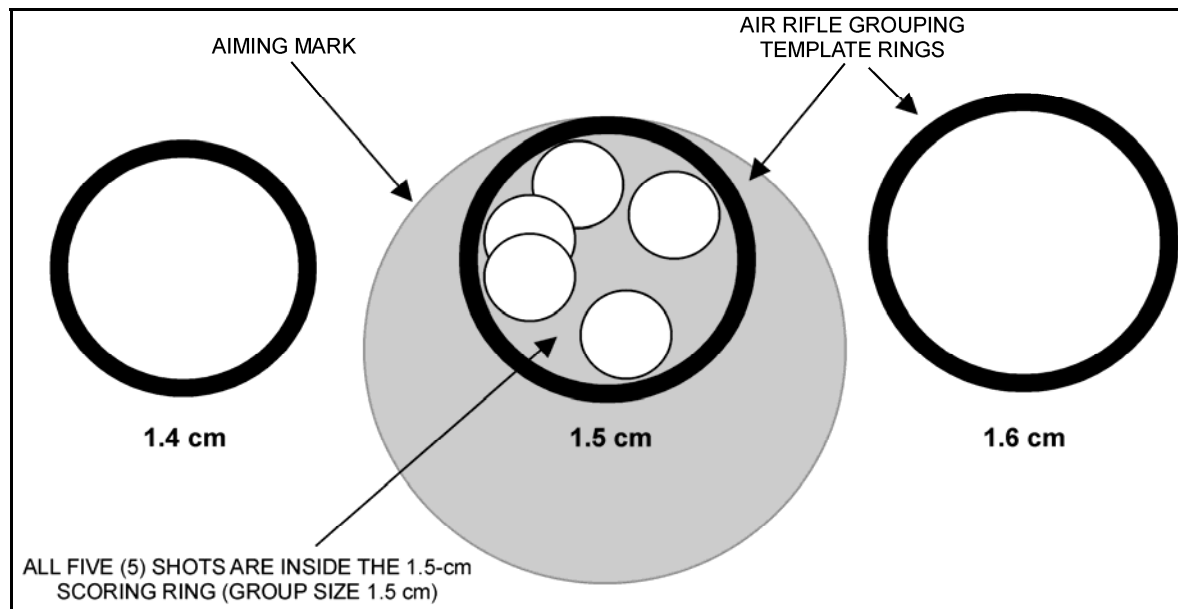

### Scoring Magnifier

A scoring magnifier is a magnifying overlay that can be used for close viewing of a shot hole. This device does not affect the shot hole. The device has engraved ring(s) the diameter of a pellet which is placed over the pellet hole. The engraved ring is centered over the pellet hole, and the engraved ring is used to determine if the shot hole touches the scoring ring.

- a. Shots which do not touch the scoring ring receive the lower value in score;
- b. Shots which touch or are tangent to the scoring ring receive the higher value in score; and
- c. Shots which break the scoring ring receive the higher value in score.



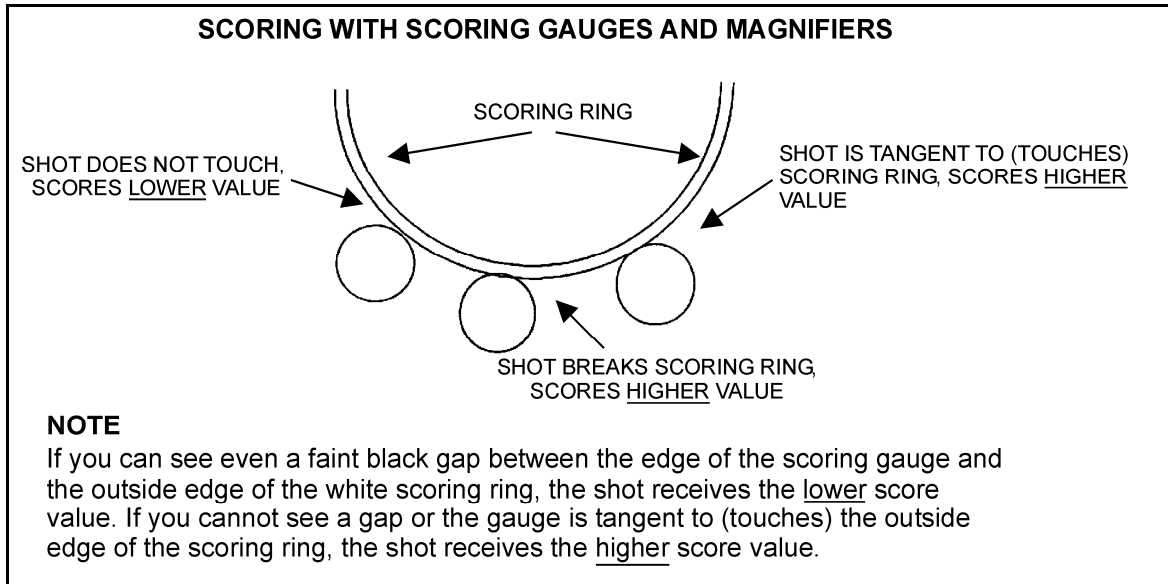

### Scoring Plug

A scoring plug is a device with a clear plastic flange which can be inserted into a shot hole, with the flange being used to magnify the area around the hole. This gauge will affect the pellet hole and consequently may only be used once in any shot hole. When a scoring plug is used on a shot hole, it should be marked as "PLUGGED". Once a shot hole is scored using a scoring plug, it should not be subject to a scoring plug again.

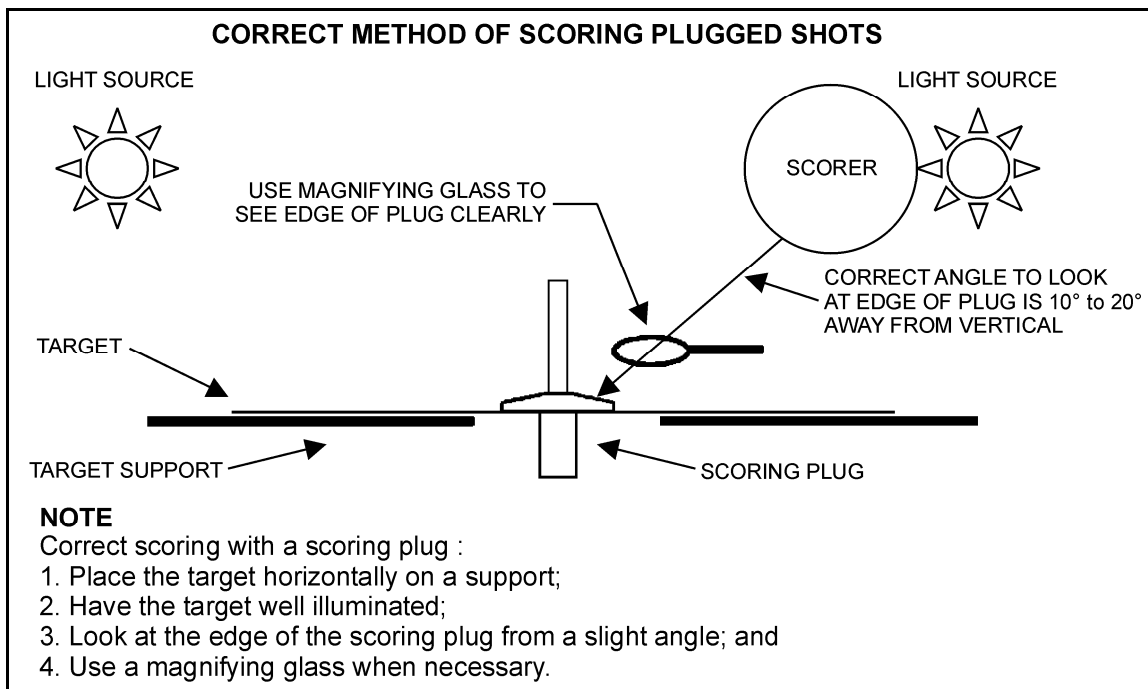

### Scoring Template

A scoring template consists of transparent material engraved or printed with outlines of the pellet diameter and possible scoring rings. It is used to reconstruct the positions of the scoring ring and shot holes. It is used primarily in matches where multiple shots are fired on individual targets and the scoring rings can potentially be removed during the course of fire.



## SECTION 10

### CLEANING

No one should attempt to clean a rifle until individual safety precautions have been performed on the rifle and it is certain that the barrel is clear of any obstructions.

#### 10.1 CLEANING THE BORE

##### 10.1.1 General

A dirty bore will eventually cause accuracy problems. Many inaccuracy complaints can be traced back to dirty bore usage. Therefore, air rifles must be cleaned and maintained on a regular basis in order to ensure sustained accuracy.

Although air rifles do not suffer from powder deposits as do smallbore and largebore rifles, they do however, experience a build-up of residue in the barrel. This residue takes two (2) forms: leading and caking. "Leading" residue results from traces of lead pellet that are left inside the bore as the pellet travels down the barrel. "Caking" results when residue from compression chamber air blown into the bore condenses in the barrel.

It is important to note that air in the compression chamber will be super heated for a fraction of a second during the firing sequence. This can cause "dieseling" – the detonation of the lubricant inside the chamber. Only high flash point lubricants (i.e., SAE 30 motor oil) are approved for use on air rifles and are to be used for their cleaning and maintenance.

##### 10.1.2 Cleaning Pellets

The 0.177 calibre felt cleaning pellets are simply inserted into the chamber and fired in the same manner as a normal pellet. Felt cleaning pellets are stamped to the optimum diameter for cleaning the bore. The natural elasticity of the felt results in compression of the pellet during firing, forcing it to expand to the diameter of the barrel, and thus ensuring that the entire bore is cleaned and polished. When conducting preservation maintenance, the natural absorbency of felt allows it to hold oils and lubricants, resulting in an even, protective film throughout the barrel.

##### 10.1.3 Before and After Firing Cleaning

Before and after firing, two (2) to three (3) felt cleaning pellets should be fired through the bore to ensure it is clean.

##### 10.1.4 Periodic Cleaning

The bore must also be thoroughly cleaned after every 1000 shots fired.



Petroleum-based cleaners or preservatives must not be used. These solvents will damage seals and may result in dieseling. Use only SAE 30 motor oil.

The following steps should be followed for periodic cleaning:

- a. Fire a felt cleaning pellet soaked in SAE 30 motor oil and wait five (5) minutes; and
- b. Fire three (3) felt cleaning pellets.

**10.1.5 Cleaning Before Storage**

For purposes of preservation and bore deterioration prevention, a rifle that is to be stored over a three (3) month period of time or longer should have two (2) or three (3) felt pellets as well as a felt pellet soaked in SAE 30 motor oil fired through its barrel. No other felt pellets should be fired as the oil should remain in the barrel.

<b>CLEANING THE BORE</b>	
<b>When</b>	<b>Action</b>
Before firing	Fire 2-3 felt cleaning pellets.
After firing	Fire 2-3 felt cleaning pellets.
Periodic	<ol style="list-style-type: none"> <li>1) Fire a felt cleaning pellet soaked in SAE 30 motor oil;</li> <li>2) Wait five (5) minutes; and</li> <li>3) Fire three (3) felt cleaning pellets.</li> </ol>
Storage of three (3) months or longer	<ol style="list-style-type: none"> <li>1) Fire 2-3 felt cleaning pellets;</li> <li>2) Fire one (1) felt cleaning pellet soaked in SAE 30 motor oil; and</li> <li>3) Fire three (3) felt cleaning pellets when taking rifle out of storage.</li> </ol>

**10.2 CLEANING OF OTHER PARTS**

**10.2.1 Stock**

The stock should be frequently wiped clean with a damp cloth.

**10.2.2 Exterior Metallic Parts**

The exterior metallic parts of the rifle should be cleaned on a regular basis with the aid of a lightly oiled flannel patch. The pivot points should also be **lightly** lubricated on a regular basis.

## SECTION 11

### MAINTENANCE

Rifles will only be taken apart to carry out authorized repairs as needed. Unnecessary stripping will only contribute to premature wear of the rifle parts.

#### 11.1 TYPES OF MAINTENANCE

There are three (3) types of maintenance on air rifles that will be conducted at the unit level. They are:

- a. Before firing maintenance;
- b. After firing maintenance; and
- c. Storage or preservation maintenance.

##### 11.1.1 Before Firing Maintenance

Before firing maintenance is conducted at the start of each training session. It consists of:

- a. A general inspection of the rifle to ensure its sights are properly attached, its screws are tight, and it is clean and functioning properly; and
- b. Under the direction of the RSO, two (2) or three (3) felt cleaning pellets will be fired through the barrel to ensure it is clean.

##### 11.1.2 After Firing Maintenance

After firing maintenance is conducted at the end of each training session. It is intended to ensure the rifle is clean, functioning, and will be ready for the next training session. It entails the following:

- a. Under the direction of the RSO, two (2) or three (3) felt cleaning pellets will be fired through the barrel; and
- b. All external parts of the rifle will be cleaned.

##### 11.1.3 Storage or Preservation Maintenance

Storage or preservation maintenance will be conducted at any time when a rifle is stored for more than three (3) months without firing. It consists of:

- a. The general cleaning of the exterior parts and **light** oiling of all exposed metal parts; and
- b. The firing under controlled conditions of:
  - (1) a felt cleaning pellet through the barrel;
  - (2) a felt cleaning pellet soaked in SAE 30 motor oil through the barrel; and
  - (3) three (3) felt cleaning pellets when taking the rifle out of storage.

#### 11.1.4 Pump Piston Lubrication

The piston should be lubricated after every 1000 pellets fired. To lubricate the piston:

- a. Turn the rifle upside down;
- b. Open the pump lever to full extension; and
- c. Insert **one (1) drop** of SAE 30 motor oil in the place indicated "OIL HERE".

#### NOTE

Do not saturate the piston with oil. Usage of a non-recommended oil is dangerous and can damage the mechanism. Use only high flash point lubricants.

### 11.2 DISASSEMBLING THE RIFLE

#### 11.2.1 General

Prior to disassembling a rifle, ensure that you have a clean working area. The video produced by Daisy Manufacturing and distributed by the CCM is a good reference tool for disassembling and reassembling the rifle.

#### NOTE

Malfunctioning rifles can be returned to the Local Cadet Detachments and exchanged for functioning rifles. No one should attempt to repair a rifle unless they are confident they are able to perform this task.

The following tools and supplies are required to disassemble and reassemble the Daisy 853C rifle:

- a. Clean, lint free rags;
- b. SAE 30 motor oil;
- c. General purpose grease;
- d. Two (2) No. 2 Phillips screwdrivers;
- e. One (1) small flat-blade screwdriver;
- f. One (1) 1/4 in. open end wrench; and
- g. One (1) 1/8 in. pin punch, two in. long.

## 11.2.2 Disassembly

The following steps should be followed when disassembling the Daisy 853C air rifle:

### Disassembly of the stock from the bared action

- a. Pull the bolt back and remove the single pellet adapter;
- b. Remove the two (2) Phillips screws from the fore end of the stock. It may be necessary to use two (2) screwdrivers if the nuts turn in the stock. Once the screws are removed, use the 1/8 in. punch to push the nuts out of the stock. Remove the spacer held in place by the rear screw;

#### NOTE

The nuts are always inserted from the right side of the stock.

- c. Remove the screw at the rear of the trigger guard. If it does not come all the way out, leave it for later removal;
- d. Extend the pump lever to the forward position and turn the rifle upside down;
- e. Place the safety catch midway between safe and fire to provide clearance with the stock;
- f. Push down on the trigger guard with your thumb until it clears the stock. Place your other hand midway along the stock to catch the fillers as the action clears the opening. When the rear of the action is clear, move the stock slightly forward and remove it over the pump lever;
- g. Remove the fillers and the barrel band;
- h. Push the spacer out from between the barrel and frame;

### Disassembly of the receiver

- i. Remove the two (2) receiver screws. The receiver is removed by rotating the rear of it upwards with your thumb. Make sure you control the bolt handle as it is under spring pressure. Lift the receiver clear and remove the bolt handle and spring;
- j. Pull back on the trigger lock lever and remove the bolt, being careful not to damage the thin portion on the front;

### Disassembly of the pump and valve assembly and verification of the o-rings

- k. With the aid of a flat-blade screwdriver, pry out the two (2) tabs on either side at the rear of the frame just far enough to clear the valve body. Slide the frame forward to remove it;
- l. Remove the lever axis pin and slide the frame clear of the pump lever assembly;
- m. If the plunger must be replaced, remove it from the lever assembly by pushing the connecting pin out using a small punch. During reassembly, ensure that the connecting pin does not protrude from either side of the plunger;
- n. Slide the frame over the plunger and replace the lever pin;

- o. To disassemble the valve group, first remove the pump tube by sliding it forward over the o-ring. Then move the flat retainer to the side until it clears the protrusion that holds it in place. It is under spring tension. As the retainer is forced up by the spring, it will be stopped when the spring contacts the inner shoulder of the retainer. A little manipulation is now necessary to remove the retainer over the spring; and

#### **NOTE**

It is absolutely necessary that this area be kept clean. Any dirt entering this area will cause premature failure.

- p. The o-ring and valve assembly can be replaced as necessary if pressure is leaking and the muzzle velocity drops during firing.

### **11.3 REASSEMBLING THE RIFLE**

#### **11.3.1 Reassembling**

The following steps should be followed to reassemble the Daisy 853C air rifle:

##### **Reassembling the pump and valve assembly**

- a. Lightly oil the valve and insert it into the valve body along with the spring. Insert the rectangular extension of the valve retainer under the lip at the valve opening. Push the retainer down against the spring tension until it is fully seated and held in position by the protrusion on the valve body, thereby engaging the hole in the retainer;
- b. Replace the pump lever latch by pushing it down and forward against the spring compression until it clips into its recess;
- c. Place the pump tube over the front end of the valve body with the deep “V” groove pointing towards the muzzle. Carefully work the tube over the o-ring so as not to damage it. Align the small groove in the tube with the protrusion on the valve body and push the tube into place;
- d. The frame and pump lever is replaced as an assembly. Place the frame over the pump tube and slide it to the rear. Carefully work the o-ring and wiper into the tube so as not to damage them. When they are inside the tube, move the pump lever forward. The frame will slide to the rear. Align the tabs on the frame with the protrusions on the valve body and squeeze them into place;

##### **Reassembling the receiver**

- e. Raise the trigger lock lever and replace the bolt by first inserting the long protrusion into the chamber. Slide the bolt down and forward into place. The bolt handle and spring can now be replaced on the bolt;
- f. To put the receiver back into place, push the prongs on the front end over the barrel and into the slots on top of the frame. Hold the bolt handle in place and rotate the receiver down over the valve body until the screw holes are aligned. Replace the screws;



- g. Replace the combination screw and nut behind the trigger guard and tighten it with the 1/4 in. wrench;

**NOTE**

Overtightening could cause damage to the soft metal of the valve body.

**Reassembling the bared action with the stock**

- h. Replace the spacer between the barrel and frame;
- i. Replace the barrel band, aligning the screw holes with those in the frame;
- j. Replace the fillers, aligning the screw holes with those in the barrel band and frame. The small tabs at the rear fit into the slots in the receiver;
- k. Hold the fillers together and slide the pump lever through the opening in the stock. Slide the action all the way forward. Centre the safety catch and slide the action down into the stock;
- l. Insert the 1/8 in. punch into the front screw hole in the stock, and wiggle it around to align all components. The screw is inserted from the left side, and the nut from the right;
- m. Insert the rear stock spacer with the flat portion away from the action and the screw hole aligned with those in the stock. The screw is inserted from left to right;

**NOTE**

Overtightening the screws may damage the stock.

- n. Replace the half moon spacer and screw at the rear of the trigger guard; and
- o. Return the pump lever to the latched position.

**11.3.2 Functioning Tests After Re-assembly**

After reassembling the rifle, a functioning test needs to be performed in order to verify that the rifle has been put back together correctly. The function test is carried out in two (2) steps as follows:

- a. **Safety Catch/Pump Assembly Test.** Pump the rifle, pull back the bolt, load a cleaning pellet, place the safety catch to ON, and pull the trigger. The rifle should not fire. Place the safety catch to OFF and pull the trigger. The rifle should fire.
- b. **Feed Action Test.** To verify the functionality of the feed action, insert a five (5) pellet clip in the rifle. Pull back the bolt, push it forward and pull the trigger while observing the feed action of the clip (pumping and pellets are not required).

### 11.3.3 Checklist

The following checklist will help in disassembling and reassembling the rifle by ensuring that all the necessary steps are completed.

ITEM	COMPLETED
<b>Disassembly</b>	
1) Remove the single pellet adapter	
2) Remove the stock from the barrelled action	
3) Disassemble the fillers	
4) Disassemble the barrel band	
5) Disassemble the spacers	
6) Disassemble the receiver	
7) Remove the bolt handle and the spring	
8) Remove the bolt	
9) Remove the frame	
10) Remove the pump assembly	
11) Remove the plunger	
12) Remove the pump lever latch	
13) Remove the valve group	
<b>Maintenance</b>	
1) Verify the condition of the plunger's o-ring and felt washer and replace or lightly oil them if required	
2) Verify the condition of the plunger and replace it if required	
3) Verify the condition of the pump cylinder's o-ring and felt washer and replace or lightly oil them if required	
<b>Reassembly</b>	
1) Replace the valve	
2) Replace the plunger	
3) Replace the pump lever latch	
4) Replace the pump assembly	
5) Insert the bolt	
6) Insert the bolt handle and the spring	
7) Reassemble the receiver	
8) Reassemble the spacers	
9) Reassemble the barrel band	
10) Reassemble the fillers	
11) Reassemble the barrelled action in the stock	
12) Reassemble the single pellet adapter	
13) Lubricate the pump piston foam wiper ring	
14) Lubricate the pump lever pivot points	
<b>Test After Reassembly</b>	
1) Verify the correct functioning of the safety catch and the pump assembly	
2) Verify the correct functioning of the feed mechanism	

## SECTION 12

### INTRODUCTION TO COACHING

#### 12.1 GENERAL

The role of a coach is to aid, assist, teach and help improve a cadet's performance. A good coach's marksmanship skills can be successfully taught to an individual (i.e., skills, knowledge, enthusiasm, encouragement, positive attitude, and concentration) and will result in an improved marksmanship performance. A good coach is able to recognize and improve imperfections in position, holding and firing.

#### NOTE

When a verbal explanation or direction is insufficient, it may be necessary to physically adjust a cadet's position or to monitor breathing. Coaches must inform the individual of the actions they are about to take, and request permission to do so.

#### 12.2 DUTIES

A coach's duties include:

- a. Providing positive reinforcement;
- b. Instilling self-confidence;
- c. Maintaining a coaching diary;
- d. Correcting marksmanship principles and techniques;
- e. Correcting position problems;
- f. Analyzing targets; and
- g. Dedicating time and energy to cadets.

#### 12.3 FIRING POINT SEQUENCE

Coaches should take the following actions on the firing point:

- a. Position themselves on the right hand side of the cadet (left side for a left-handed individual) or at the back of the firing lane in the best position to observe without disturbing the individual or their position;
- b. Ensure that the cadet is lined up on the correct target and that the rear sight is correctly set and centered;
- c. Observe the individual's natural alignment. If necessary, adjust their:
  - (1) position;
  - (2) hold (coaches should be particularly aware of possible canting – when the cadet fires the rifle while it is tilted to the side);

- (3) eye relief;
  - (4) breathing sequence; and
  - (5) trigger squeezing; and
- d. Encourage the individual to relax and to rest during his relay.

## 12.4 COMPETITION FIRING

### 12.4.1 Cadet Coach

A cadet coach is defined as any cadet who has been appointed by the adult coach to carry out coaching duties while on the firing point. The following guidelines apply to cadet coaches while in competition:

- a. The cadet coach is permitted to coach on the firing point;
- b. The cadet coach may assist the competitor in cocking the Daisy 853C while on the firing point;
- c. The cadet coach may not touch the competitor or support their rifle while aiming or firing;
- d. The cadet coach may assist the competitor in adjusting their sights; and
- e. Verbal communication with competitors is not permitted during competitions.

### 12.4.2 Adult Coach

An adult coach is defined as a member of the CF or a CI responsible for the cadets. An adult coach is not permitted to coach while a cadet is on the firing point during a competition. The coach may, however, observe from the coaches box, situated at the rear of the range.

## 12.5 ANALYSIS OF COMMON ERRORS

The coach must help the cadet in understanding their errors and teach them how to properly correct them. The following diagrams illustrate eight common errors, and will aid in analyzing specific grouping patterns.

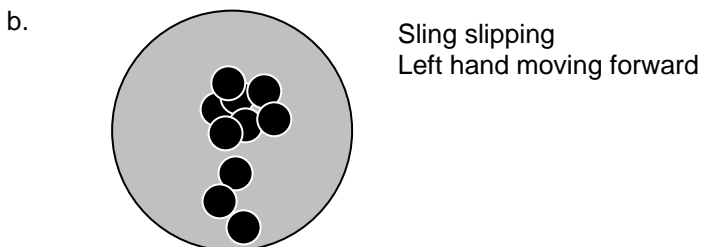
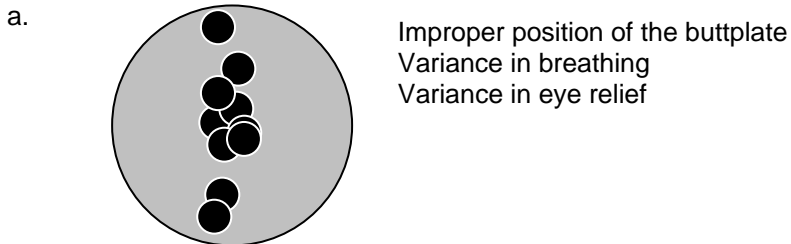

c.

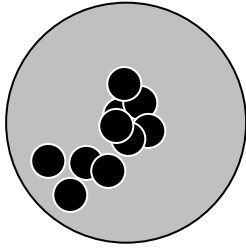

Anticipation of recoil

d.

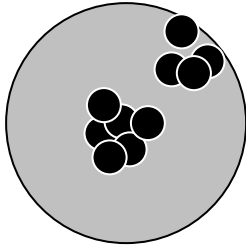

Anticipation of recoil

e.

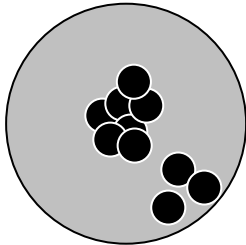

Jerking the trigger

f.

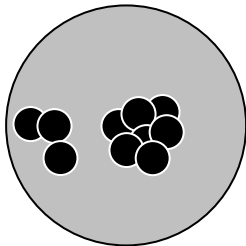

Squeezing the trigger at an angle  
Improper usage of the sling

g.

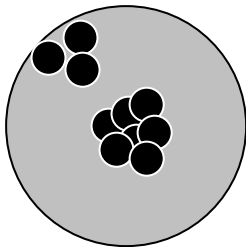

No follow-through or anticipation

h.

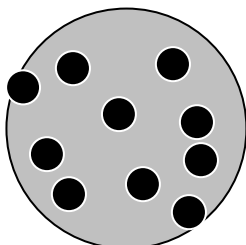

Poor usage of marksmanship principles or barrel  
needs replacing



## SECTION 13

### MARKSMANSHIP EQUIPMENT

#### 13.1 GENERAL

Marksmanship equipment such as jackets, mats, hats, gloves, scopes and slings may be used during practice and competition. Corps and squadrons must ensure that they only use equipment and apparel that complies with the rules of the CCM Marksmanship Championship Series. Prior to the beginning of a competition, each competitor must submit all equipment and apparel to the equipment check for official inspection and approval.

#### 13.2 MARKSMANSHIP APPAREL

##### 13.2.1 General

Cadets performance can be easily improved by providing them with adequate apparel. This apparel will help to increase both stability and comfort.

It is not necessary to purchase equipment that is custom-made for marksmanship. Locally produced apparel is sometimes just as good as more expensive, specialized equipment. For example, it is possible to substitute a ski glove for a marksmanship glove, or to have marksmanship jackets produced by a tailor in the community.

##### 13.2.2 Restrictions

The use of any special devices, means or garments that immobilize or unduly reduce the flexibility of the competitor's legs, body or arms is prohibited. All clothing must be made of soft, flexible and pliable material that does not become stiffer, thicker or harder under normal firing conditions. Adhesives or the use of other materials on the clothing to assist the position are also prohibited.

Certain specifications apply to each type of marksmanship apparel. For exact specifications, see the *CCM Marksmanship Championship Series Rule Book*.

##### 13.2.3 Marksmanship Jacket

A jacket offers some support and helps stabilize the body. Only jackets made of single layer cotton twill are permitted in cadet competitions. Rubber pads are attached to the elbows and to the right shoulder to soften contact with the ground and with the rifle. Another pad can be attached to the left arm in order to support the sling and lessen the pressure caused by it. The jacket must be large enough to permit the wearing of sweaters. The jacket also helps to reduce the pulse felt from the upper arm.

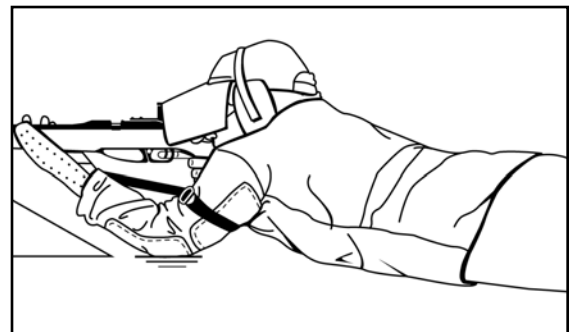

### 13.2.4 Marksmanship Glove

The marksmanship glove protects the back or interior of the hand against pressures created by the sling and the sling swivel. It can either be in the form of a glove or a mitt.

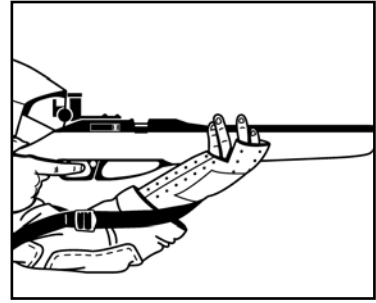

### 13.2.5 Marksmanship Hat

The marksmanship hat has flap sides and an elongated peak, which creates a tunnel vision and helps in avoiding neighbouring distractions.

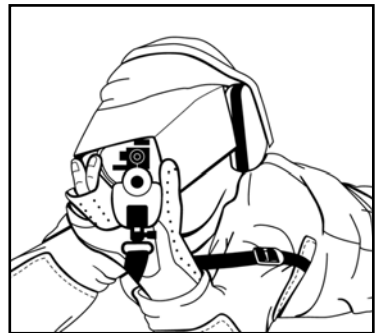

### 13.2.6 Sweaters

It is of the utmost importance to wear at least one sweater under the marksmanship jacket. If possible, two (2) sweaters should be worn. These sweaters increase stability and absorb pulse beat. The marksman must be comfortable and his jacket must be big enough to permit the wearing of sweaters.

### 13.2.7 Sling

The only sling permitted for use in the CCM is the sling issued with the Daisy 853C. The sling helps to support the weight of the rifle, ensuring minimal muscular effort on the part of the marksman.

### 13.2.8 Blinder

A blinder is a vision blocking device, attached to the rifle sight or the competitor's glasses, that is used to help prevent squinting and eye fatigue. The blinder should be translucent or white so that it allows light to pass through it.

### 13.2.9 Telescope

Telescopes are used so that the cadet or coach can view the target and make sight adjustments based on the fired shots. The scope must be mounted off the rifle and it must not act as an artificial support for the marksman.

### 13.2.10 Mats

Mats or ground sheets are used to aid the comfort of the cadets. However, they may not be used to provide an artificial support.



### **13.2.11 Table, Chairs or Adjustable Device**

Tables, chairs or adjustable devices are used in the standing and kneeling positions. These aids are used to ensure all equipment (scope, tools, inserts, etc.), pellets and targets are close enough to the cadet so the position is not affected when requiring these items during a course of fire. The table, chair or adjustable device must not act as an artificial support for the cadet.

### **13.2.12 Kneeling Roll**

A kneeling roll is placed under the right foot in the kneeling position. The kneeling roll is an optional piece of equipment and some cadets may find it improves comfort and stability in the kneeling position.



## SECTION 14

### PHYSICAL TRAINING

#### 14.1 GENERAL

Physical training improves and develops the strength and endurance required to hold the rifle steady for long periods of time without fatigue. Aerobic training will also improve the cardiovascular system, which in turn will rest the heart rate and improve the efficient transport of oxygen. In short, the higher the level of fitness in an individual, the more consistent, regular and lower their pulse will be.

Obviously, the best way to train the muscle groups that will be used in marksmanship is to carry out live or dry firing exercises.

Before a competition or practice, a warm-up exercise is recommended in order to get the blood flowing and the muscles tuned. Stretching exercises can help the individual's flexibility and level of comfort during the firing session.

#### 14.2 WARM-UP EXERCISES TO BE DONE BEFORE STATIC STRETCHING

While firing, the individual maintains a static position that demands a lot of muscular stamina. A good stretch puts the muscles in movement and warms them up, thereby getting the blood flowing to the muscles that will be used when firing. These exercises will help the cadet keep a stable and comfortable position. Each exercise should last about 20-30 seconds and it is important that cadets not bounce or jerk when doing them.

The following warm-up exercises should be done before stretching:

- a. **Neck.** Standing feet astride, turn the head in semi-circles to the left and to the right.



- b. **Shoulders.** Standing feet astride with the arms by the sides, rotate the shoulders forwards and backwards.

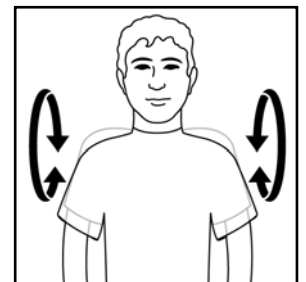

- c. **Trunk.** Standing feet astride with the arms by the side, rotate the trunk to the left and to the right.

**NOTE**

When doing these exercises, do not bend backwards as it is dangerous for their back.

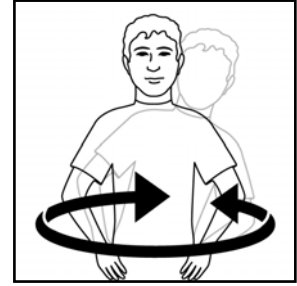

**14.3 STATIC STRETCHING EXERCISES**

Stretching muscles can be compared to stretching an elastic band. In static stretching, the elastic band is stretched slowly. It is a controlled and maintained movement. In dynamic stretching, the elastic band would be pulled and released quickly (bounced). Only static stretching should be done for exercises related to marksmanship. This way, individuals will know to what point their muscles should be stretched while in the firing position.

**14.3.1 Guidelines to Follow When Stretching**

The following stretching exercises are used to increase flexibility, which will in turn facilitate muscle control and relaxation. The exercises presented in this section are called self static stretching exercises since individuals perform their own exercises with a steady force through the joint range of motion, rather than with a bobbing up and down force. The following guidelines should be adhered to when stretching:

- a. Initially it is not important that individuals be flexible. The important point is that they learn how to stretch their muscles properly and develop a liking for the stretching exercise;
- b. Individuals should not compare themselves with others. Genetically, everyone is different;
- c. Stretching exercises are to be done prior to a physical workout, range practice or competition;
- d. Stretching exercises are to be done slowly with no sudden jerks or bouncing;
- e. Individuals should stretch as far as they can until a **slight** burning sensation is felt in the muscle being stretched;
- f. Individuals should concentrate on good technique and form; and
- g. Individuals should try to adopt a flexibility-stretching program to be carried out daily for maximum benefit.

### 14.3.2 Stretching Exercises

The following exercises are advisable to perform before a firing session and should each last for about twenty seconds:

- a. **Head and Neck.** Standing feet astride with the hands on the hips, bend the head forward and bring it back to its original position. Then, bend the head sideways as well as turn it from left to right in slow stretching motions.

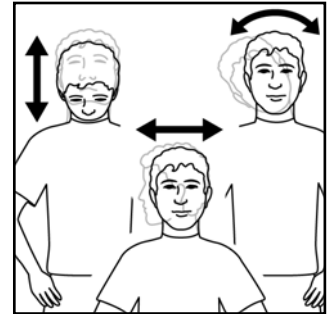

- b. **Shoulders, Arms and Wrists**

Standing feet astride with the arm bent across the chest, pull the arm across the chest with the opposite hand. Repeat this sequence for both arms.

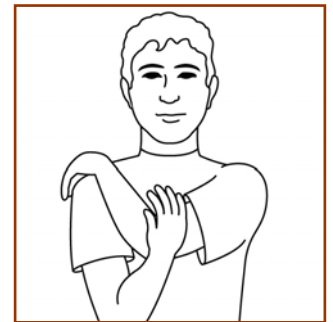

Standing feet astride with the arms raised overhead, hold the left elbow with the right hand. Bend the left hand down between the shoulder blades. Using the right hand, slowly push downward on the elbow. Repeat this for both arms.



Standing with the feet astride and the arms raised forward, using one hand, push the fingers of the other hand backwards. Repeat this exercise for both wrists.

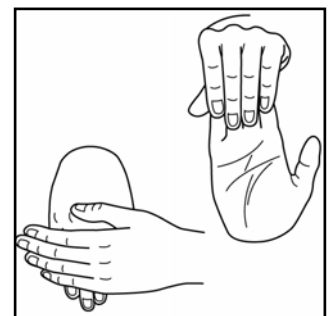

Using one hand, push the fingers of the other hand downwards. Repeat this for the other wrist.

- c. **Back.** For the **upper back**, stand against a wall and pull the knee up to the chest. Hold the knee with the hands and push down. Repeat this sequence with both knees. For the **lower back**, stand while bending the knees slightly and bend down and touch the toes. Bend down as far as possible in a controlled movement and then return to a straight-up position.

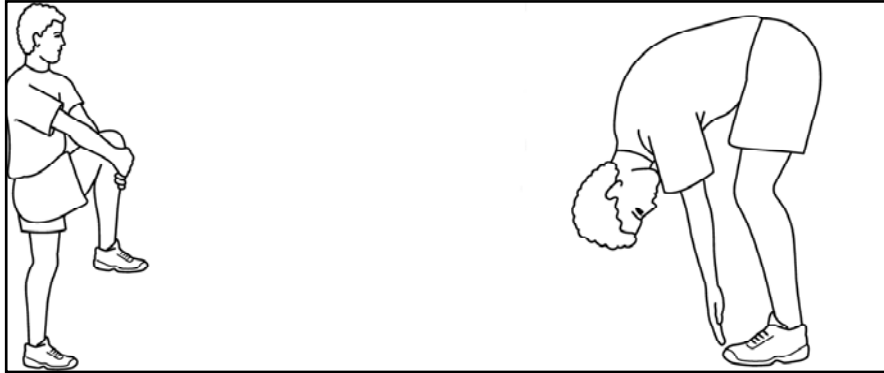

#### 14.4 DIET

Carbonated beverages, coffee and tea contain caffeine, which affects the heartrate and can adversely affect an individual's performance. These drinks should not be taken close to the time of a competition or practice. It is also advisable to eat lightly before a competition or a practice, as eating too much can cause an elevated heartrate and the added discomfort of a full stomach. As dehydration is a common problem, it is strongly advisable to drink liquids such as water or diluted juice prior to a competition.

#### 14.5 RELAXATION TECHNIQUES

##### 14.5.1 General

Stress can cause mental tension that may result in muscle tension. This may in turn cause trembling which will cause the rifle to shake. When muscles are relaxed, the mind will also be relaxed and the heart rate will lower. Relaxation techniques can help the cadet to focus on the firing sequence.

There are many ways that an individual can break the tension experienced during a match, i.e., by taking pauses during the match or by breathing deeply. Being in a relaxed state can greatly improve a cadet's performance.

##### 14.5.2 Relaxation Methods

A very reliable relaxation method involves concentrating on each set of muscles, starting with the muscles in the toes and gradually working up through the body to the facial muscles. This exercise can be done anywhere and will help calm a cadet before a competition. This exercise provides the best results when cadets are performing it while lying on their backs. It should be practised for 10-15 minutes each day and incorporated into an individual's preparation prior to firing. Cadets should concentrate on each muscle, tense it for about ten seconds and then relax it. They should repeat this exercise for each muscle group (always working upward towards face).

Cadets should follow this sequence when doing this exercise:

- a. Curl the toes and then relax them;
- b. Tense up the calf muscles and relax them;
- c. Tense up the thigh muscles and relax them;
- d. Tense up the buttocks and relax it;
- e. Tense up the abdominal muscles (stomach) and relax them;
- f. Curl the arms (biceps) and relax them;
- g. Hyperextend the arms (triceps) and relax them;
- h. Clench the fists and relax them; and
- i. Tense up the face muscles and relax them.

#### **14.5.3 Relaxation Breathing Exercise**

A very effective method to relax the body involves the following breathing exercise:

- a. Cadets sit cross-legged with the palms of their hands open;
- b. Cadets then close their eyes;
- c. Cadets then take ten (10) deep stomach breaths closing one finger for each breath; and
- d. Once all their fingers are closed (ten (10) breaths have been taken), coaches should ask the cadets to slowly open their fingers.

However, the best way to be relaxed when firing is to be prepared. When laying down to fire, cadets should know where all their different pieces of equipment are and should not be worried about forgetting anything or looking around for pellets or ear protection.





## SECTION 15

### MENTAL TRAINING

#### 15.1 GENERAL

Sports psychology has proven extremely beneficial in marksmanship. Attitude, positive outlook and motivation are very important aspects of this sport. This form of training is used to develop methods to control thoughts before, during, and after firing. Sports psychology will help individuals to concentrate on the task at hand and prevent their focus from drifting away from their plan when something unexpected happens.

#### 15.2 MENTAL IMAGERY

The most common form of mental training is called mental rehearsal, mental imagery or visualization, which involves thinking through the act of firing without any physical involvement whatsoever. Mental imagery is very useful and can be done anywhere, although it has proven most effective when performed immediately after relaxation techniques.

In early stages of mental imagery, the cadet should try to envisage the firing of a single shot. The aim should be to imagine, as completely and accurately and in as much detail as possible, a perfect firing sequence, from adopting the position up to the follow-through. If parts of the sequence cannot be visualized, more work needs to be done to perfect this technique. After the sequence has been envisaged successfully, cadets should try to move their body through the sequence as if they were actually firing.

Cadets imagine themselves going through the entire match. This includes match preparation, adopting a good position as well as following the proper sequence required to fire a perfect shot (holding, aiming, breathing, squeezing trigger, follow-through). Each of these steps involves further imagery. For example, in rehearsing trigger control, the individual would concentrate on the placement of their finger on the trigger, the position of their hand on the rifle stock, and trigger release. In performing mental imagery, the cadet must imagine doing the correct procedures. The thoughts must be completely positive, as negative thoughts or incorrect procedures will affect performance.

Mental imagery differs from person to person. It is advised that each individual writes down their firing sequence and develops their own personal mental plan. However, this takes time and patience. Once done correctly, individuals will become more confident when firing because they will be completely comfortable with the procedure, having rehearsed it mentally on numerous occasions. Eventually, firing a match will become second nature to them.

Mental imagery also permits cadets to imagine what they will do if a problem arises while they are firing. For example, if they fire a bad shot, they will be able to put it behind them and concentrate on firing good ones. All thoughts should be positive. Positive thinking leads to positive outcome!



## SECTION 16

### TRAINING PLAN & MARKSMANSHIP DIARY

*Achieving success is often a function of goal setting, establishing a plan and developing a method to evaluate the plan over time.*

#### 16.1 GOALS

Establishing goals is the beginning of a successful marksmanship training plan. Goals are the “road map” to where you want to go in the future. There are three types of goals:

- a. **Long Term Goals.** Long term goals are the rewards you would like to realize in one or more years;
- b. **Medium Term Goals.** Medium term goals are the events you want to realize over one to twelve months; and
- c. **Short Term Goals.** Short term goals are very specific goals and objectives which are realized over a training period or training day. These goals are very specific and detailed. They occur every training session and assist you in realizing your medium term goals.

##### 16.1.1 Establishing Goals Must Be SMART

The term SMART refers to maximizing the potential of goals and ensuring they meet your needs. Goals should be:

- a. **Specific.** Goals must be specific in what you wish to achieve;
- b. **Measurable.** Goals require a method of determining whether or not they have been achieved. Each goal requires a quantitative method to evaluate the success;
- c. **Achievable.** The goals need to be attainable in the set period of time;
- d. **Realistic.** Goals have to be considered against what is possible. It is not realistic to establish a goal such as competing in the Olympics this year if you have never fired a rifle before; and
- e. **Timed.** When establishing your goals, consider the time in which you wish to achieve it successfully. Each goal needs a time limit to determine success.

#### 16.2 TRAINING PLAN

A training plan is a tool to help achieve your goals. By establishing a training plan, you will be able to set out a plan to achieve your long term, medium term, and short term goals.

A calendar is an easy way to record and view your training plan in an easy to view and user friendly format.

### 16.3 MARKSMANSHIP DIARY

The Marksmanship Diary is a tool used by athletes to help in their training. The diary is a detailed record of training events. Diaries take many shapes and sizes. The type of diary is not important, the information it contains is important. Feel free to develop a diary yourself, or use the easy to complete diary below for marksman and coaches.

### 16.4 SAMPLE DIARY SHEET

The diary sheet has been developed specifically for marksman using the Daisy 853C air rifle and the coaches of cadets within the CCM.

CCM Marksmanship Diary				
Date: _____	Location: _____	<input type="checkbox"/>	Standing	
Time: _____	Training/Competition: _____	<input type="checkbox"/>	Kneeling	
		<input type="checkbox"/>	Prone	
<input type="checkbox"/> Rifle Safety Check	<input type="checkbox"/> Elevation Set	<input type="checkbox"/> Right Insert	<input type="checkbox"/> Reviewed Diary	<input type="checkbox"/> First Aid Kit
<input type="checkbox"/> Safety Rod	<input type="checkbox"/> Windage Set	<input type="checkbox"/> Scope & Stand	<input type="checkbox"/> Shooting Mat	<input type="checkbox"/> Stretcher
<input type="checkbox"/> Inspect Condition	<input type="checkbox"/> Shooting Jacket	<input type="checkbox"/> Table/Stand	<input type="checkbox"/> Timer	<input type="checkbox"/> Range Flags
<input type="checkbox"/> Front Sight	<input type="checkbox"/> Shooting Hat	<input type="checkbox"/> Kneeling Roll	<input type="checkbox"/> Targets	<input type="checkbox"/> Barricade
<input type="checkbox"/> Rear Sight	<input type="checkbox"/> Shooting Glasses	<input type="checkbox"/> Pellets	<input type="checkbox"/> Pen/Paper/Diary	<input type="checkbox"/> _____
<input type="checkbox"/> Sling	<input type="checkbox"/> Ear Protection	<input type="checkbox"/> Training Goal Set	<input type="checkbox"/> Tools	<input type="checkbox"/> _____
<input type="checkbox"/> Sling Swivel	<input type="checkbox"/> Shooting Glove	<input type="checkbox"/> RSO on Range	<input type="checkbox"/> _____	<input type="checkbox"/> _____
<b>Settings:</b>		<b>Results/Groups/Scores:</b>		
Sling: _____	Other: _____	Result #1: _____	Result #6: _____	
Sling Swivel: _____	Other: _____	Result #2: _____	Result #7: _____	
Insert Used: _____	Notes: _____	Result #3: _____	Result #8: _____	
Elevation: _____	_____	Result #4: _____	Result #9: _____	
Windage: _____	_____	Result #5: _____	Result #10: _____	
<b>Goals and Objectives:</b>		<b>SMART GOALS</b>		
Long Term Goal: _____		Specific		
_____		Measurable		
Medium Term Goal: _____		Achievable		
_____		Realistic		
Training Goal: _____		Timed		
_____		_____		
_____		_____		
<b>What I Learned:</b> _____		<b>REMEMBER...</b>		
_____		Think Safe		
_____		Act Safe		
<b>Problems to Solve:</b> _____		Be Safe		
_____		_____		
_____		_____		
<b>Firing Point Sequence:</b>				
<b>Before Firing:</b>		<b>During Firing:</b>		
1. Check equipment - ensure all screws and adjustments are tight, in place, and in working order			1. Check position and repeat as required	
2. Install target safety and correctly			2. Check correct number of shots fired	
3. Correct alignment with the target			<b>After Firing:</b>	
4. Verify Position is legal and correct			1. Perform safety check on rifle	
5. Check aiming and breathing sequence			2. Ensure target and equipment picked up and returned to correct location	
6. Check trigger squeeze and follow-through			3. Diary Entry - Record results	

## ANNEX A

### DEVELOPMENT OF A MARKSMANSHIP TEAM

The development of a marksmanship team should be completed at the beginning of the training year.

- a. **Recruitment of Cadets.** The coach must ensure that the potential cadets are motivated, determined and available. The corps/squadron team must consist of five cadets including a minimum of two (2) juniors. A junior cadet must not have reached their 15<sup>th</sup> birthday on or before the 15<sup>th</sup> of May of the competition year while other cadets cannot have reached their 19<sup>th</sup> birthday by that same date. There is no limit to the number of teams within a local corps/squadron, however, only one team can represent the corps/squadron in the CCM Marksmanship Series Championship. In fact, having more teams will ensure a future pool of interest in the sport.
- b. **Firing on Grouping Targets.** During these competitions, and for the initial selection, coaches must focus their attention on the group size, cadets positions, their mastering of the marksmanship principles as well as their attitude. If cadets are capable of firing an excellent group, they are surely capable of good precision firing. At this stage, coaches should work solely on the basic principles of marksmanship (position, aiming, breathing, trigger control, and follow-through).
- c. **Pre-selection of the Team.** Based on the results of the grouping practice, coaches should choose those cadets who demonstrate the greatest potential. Junior cadets should be identified. Coaches should start a training group to maintain interest for potential members of future teams.
- d. **Precision Firing.** This practice allows coaches to determine the final team composition. Cadets' results count for the final selection. During the training session, coaches must ensure that cadets have the necessary support for a good position.
- e. **Final Selection.** With the help of precision results, coaches must then choose the members of their team. Spare team members should be identified and they should continue to train with the team. Cadets not selected should continue to practice with the training group.
- f. **Selection of a Cadet Coach.** Cadet coaches are appointed based on knowledge, ability and leadership and they are normally the most experienced cadet(s) on the team. They must be capable of zeroing their teammates and of giving them advice. During the competition, they should fire first or last in order to better combine firing and coaching duties. Also, a secondary cadet coach should be trained to perform coaching duties for the main cadet coach.
- g. **Training of Substitutes.** Cadets who are in the training group must not be neglected. They can form an excellent pool of potential team members for the future. This is why it is important to train them so that they can improve their skills and performance. Also, if cadets cannot attend a competition for one reason or another, they can be replaced by a substitute from this pool without any problem.



**ANNEX B**

**AIR RIFLE GROUPING TEMPLATE**

Coaches should switch a marksman to scoring after a 2.0 cm grouping size is achieved.

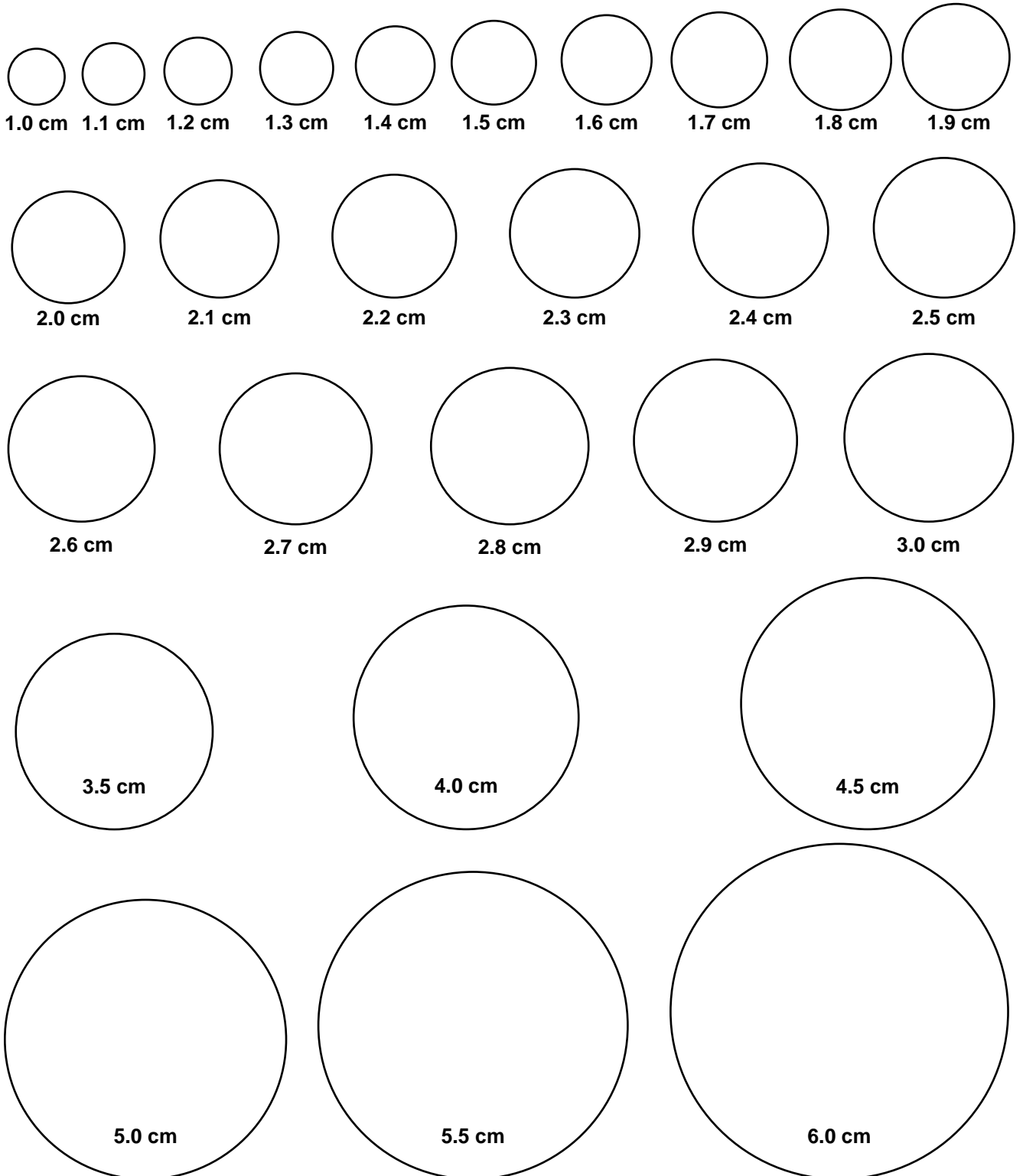





## ANNEX C

### MARKSMANSHIP REFERENCE MATERIAL

The following material provides reference on marksmanship training and coaching. It is available from various sources including National and Provincial/Territorial Shooting Associations, libraries and local bookstores.

#### C.1 CIVILIAN PUBLICATIONS

Cardew, G.V., and Cardew, G.M. *The Airgun From Trigger to Target*. G.V. & G.M. Cardew. 1995. (ISBN 0-9505108-2-3)

Churchill, B., and D. Granville. *Modern Airweapon Shooting*. Newton Abbot: David & Charles. 1981. (ISBN 0-7153-8123-7)

Domey, R. *Mental training for shooting success*. Washington, DC: College Hill Communications. 1988.

Horneber, Ralf. *Olympic Target Rifle Shooting: Technique, tactics and training*. F.C. Mayer Verlag, Munich, Germany. 1993.

International Shooting Union. *General Technical Rules*. 1997.

International Shooting Union. *Special Technical Rules*. 1997.

Krilling, W. *Shooting for Gold*.

Lujan, L. *Shooter's Guide to Position Air Rifle*. United States: Junior Shooting Sports. 1996.

National Rifle Association of America. *Learning to Shoot: A Beginner's Guide to Air Guns*. 1995.

National Coaching Certification Program. *Coaching Theory: Level I, II, And III* (English/French copies available).

Nideffer, R. *Athlete's Guide to Mental Training*. Illinois: Human Kinetics Publishers. 1985. (ISBN 0-931250-96-X).

Orlick, T. *In Pursuit Of Excellence: How to Win in Sport and Life Through Mental Training*. Illinois: Leisure Press. 1990. (ISBN 0-88011-380-4).

Orlick, T. *Psyching for Sport*. Illinois: Leisure Press. 1986. (ISBN 0-88011-273-5).

Owens, J. *Leather Sling and Shooting Positions*. Milwaukee: JAFEICA. 1996.

Owens, J. *Sight Alignment Trigger Control and The Big Lie*. Milwaukee: JAFEICA. 1996.

Pullum, B., and F. Hanenkrat. *The New Position Rifle Shooting*. Peachtree City: Target Sports Education Centre. 1997. (ISBN 0-9655780-0-3).

Pullum, B., and F. Hanenkrat. *Successful Shooting*. Washington, DC: National Rifle Association of America. 1981. (ISBN 0-935998-40-3).

Reinkemeier, H. *On The Training of Shooters: Volumes I and II* (S. Greer, B. Murray, Trans.). National Smallbore Rifle Association. 1992. (ISBN 0-9521077-1-6).

Shooting Federation of Canada National Coaching Certification Program. *Rifle Shooting Technical: Level I and II* (English/French copies available).

Shooting Federation of Canada. *Crosman Airgun Shooting Program Instruction Manual* (English/French copies available).

United States Army Marksmanship Unit. *Junior Marksmanship Rifle Guide*.

Yuryev, A. *Competitive Shooting* (Anderson, Trans.). Washington, DC: National Rifle Association of America. 1985. (ISBN 0-935998-53-5).

## **C.2 MILITARY PUBLICATIONS**

American Legion Junior Shooting Sports Program. *Basic Marksmanship Guide*.

Canadian Forces. *Shoot To Live*.

Canadian Cadet Movement. *Army Cadet National Training Centre Connaught Target Shooting Manual*.

*Canadian Cadet Movement Marksmanship Championship Series Rule Book*.

United States Army Marksmanship Unit, *Marksmanship Instructors' and Coaches' Guide*.

United States Army Marksmanship Guide, *International Rifle Marksmanship Guide*.